

Mukhtar
surgical
Instruments



**ORTHOPEDIC
INSTRUMENTS**



Company Profile

Mukhtar Surgical Instruments

Following the 21st century vision of becoming a true global leader who can make its Customers worldwide through its quality products and services. We are dedicated to manufacturing and marketing instruments which provide practical Solutions to real life problems, And meet the needs of our customers. We insist on high quality, efficient manufacturing Teamwork, and integrity, growing from our deep respect and honour for god, our Employees, our vendors, our customers and all our other stakeholders.

We stand behind every product we offer. Each of us, from the production department To the sales department makes customer satisfaction a top priority.

The careful management of people and projects ensures we continue to enjoy our Reputation for providing excellent quality services to our customers. The most important part of our philosophy is to work in partnership with clients and This requires, in our view, direct contact between our clients and us from the word go.

We aim:

- >> To listen to our customers and exceed their expectations, ensuring they are completely Satisfied with our products, services and support so that they will continue working with us.
- >> To continue expanding our research programs in progressive technologies.
- >> To secure international recognition by adopting a global rather than local perspective And by achieving excellence in the quality of our instruments.
- >> To continue building our excellent team of top professionals through controlled expansion,



GLOBAL PRESENCE

WE SUPPLY ALL OVER THE WORLD.

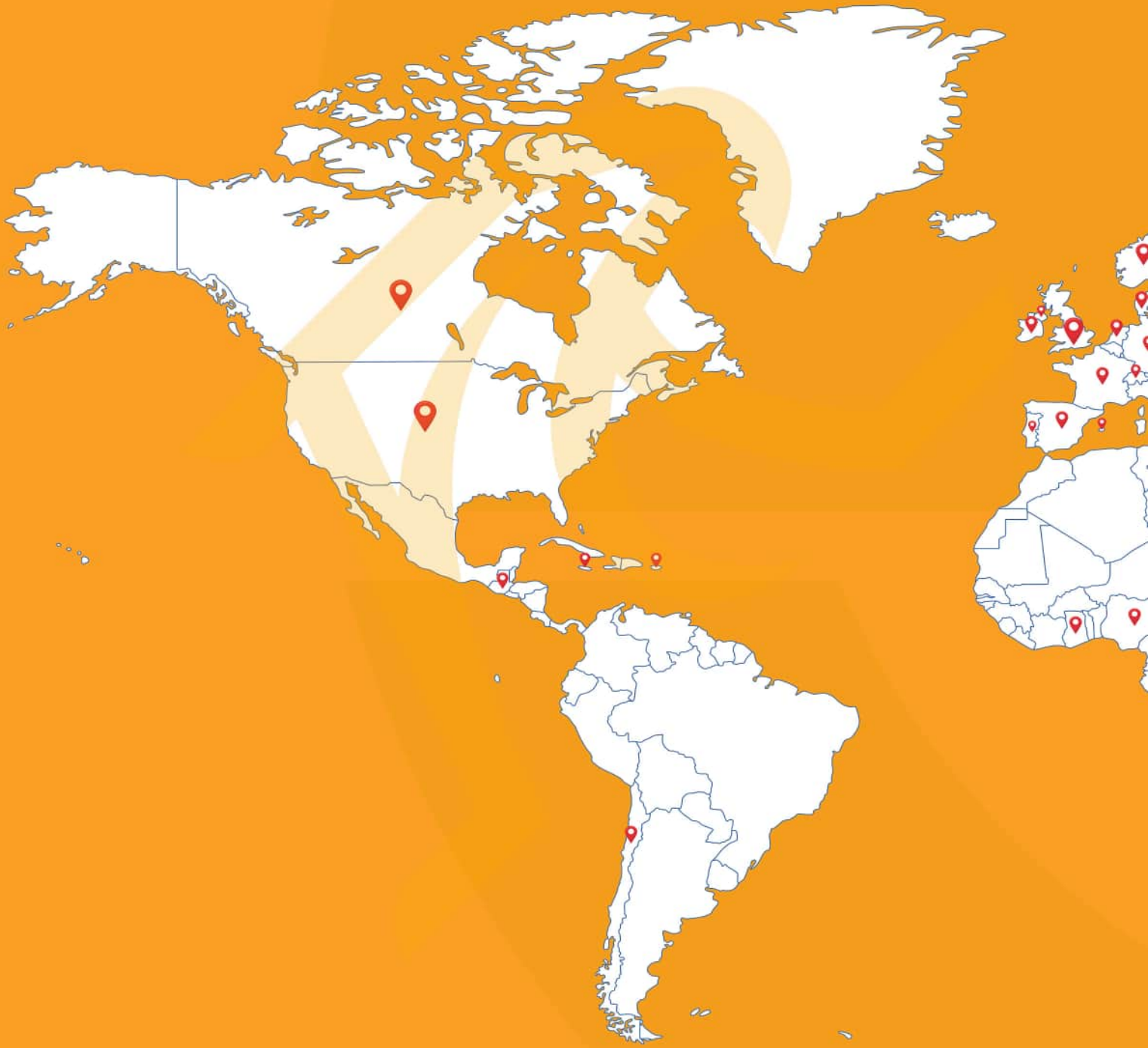

Australia, Austria, Belarus, Belgium, Bosnia & Herzegovina, Bulgaria, Canada, Chile, China, Croatia, Cyprus, Czech Republic, Denmark, Finland, France, Germany, Ghana, Great Britain, Greece, Guatemala, Holland, Hungary, India, Ireland, Israel, Italy, Jamaica, Japan, Kenya, Kuwait, Latvia, Libya, Lithuania, Malaysia, Mallorca, Malta, Mauritius, Netherlands,

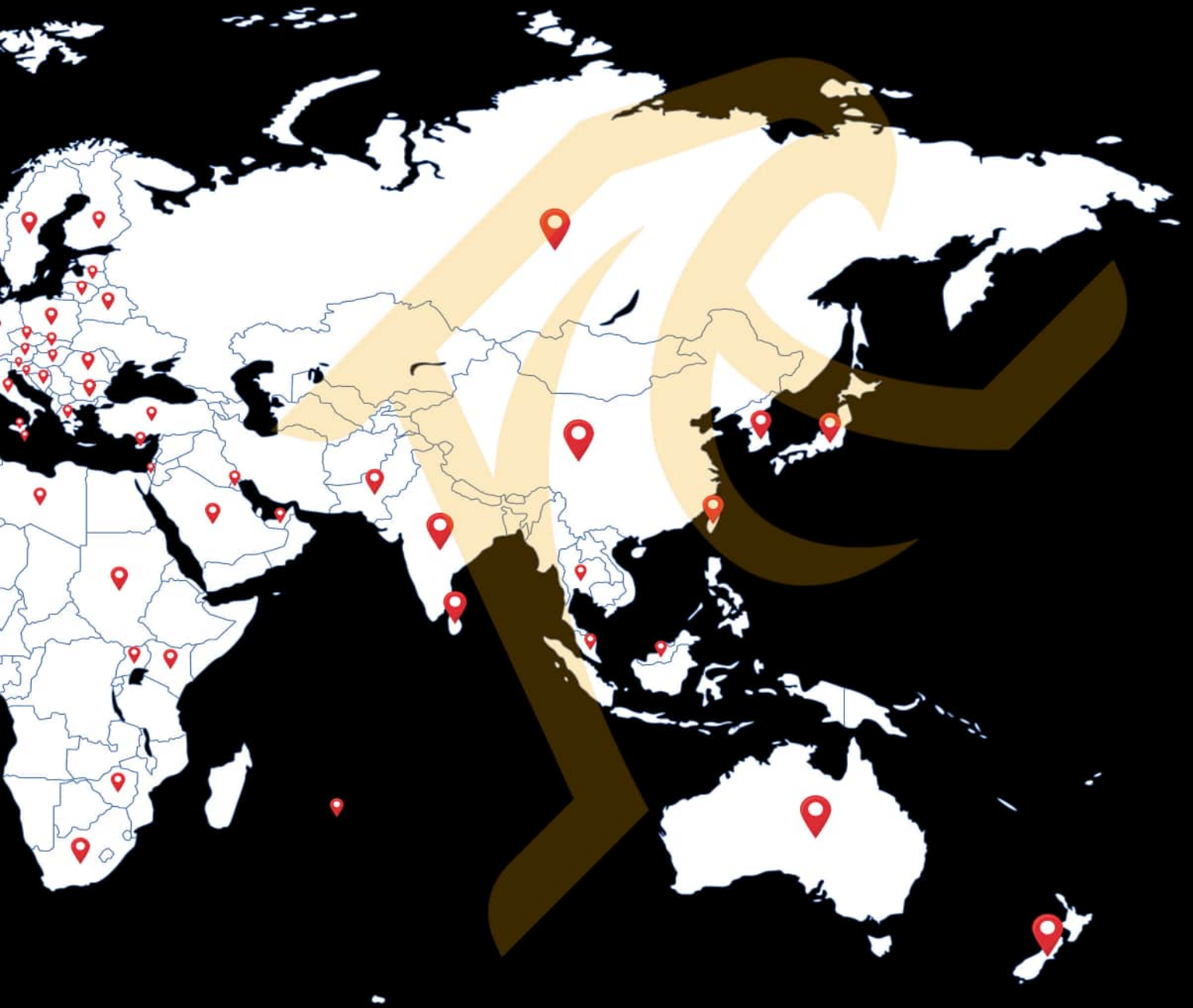

New Zealand, Nigeria, Northern Ireland, Norway, Pakistan, Poland, Portugal, Puerto Rico, Republic of Ireland, Romania, Saudi Arabia, Singapore, Siracusa, Slovakia, Slovenia, South Africa, South Korea, Soviet Union, Spain, Sri Lanka, Sudan, Sweden, Switzerland, Taiwan , Thailand, Netherlands, Turkey, Uganda, United Arab Emirates, USA, Zimbabwe



Esmarch
MO-13-100
18 cm / 7"



Reiner
MO-13-101
18.5 cm / 7 1/4"



Hopkins
MO-13-102
20 cm / 8"



Mod. Surgicon
MO-13-103
21 cm / 8 1/4"



For more bandage scissors, also see page 69

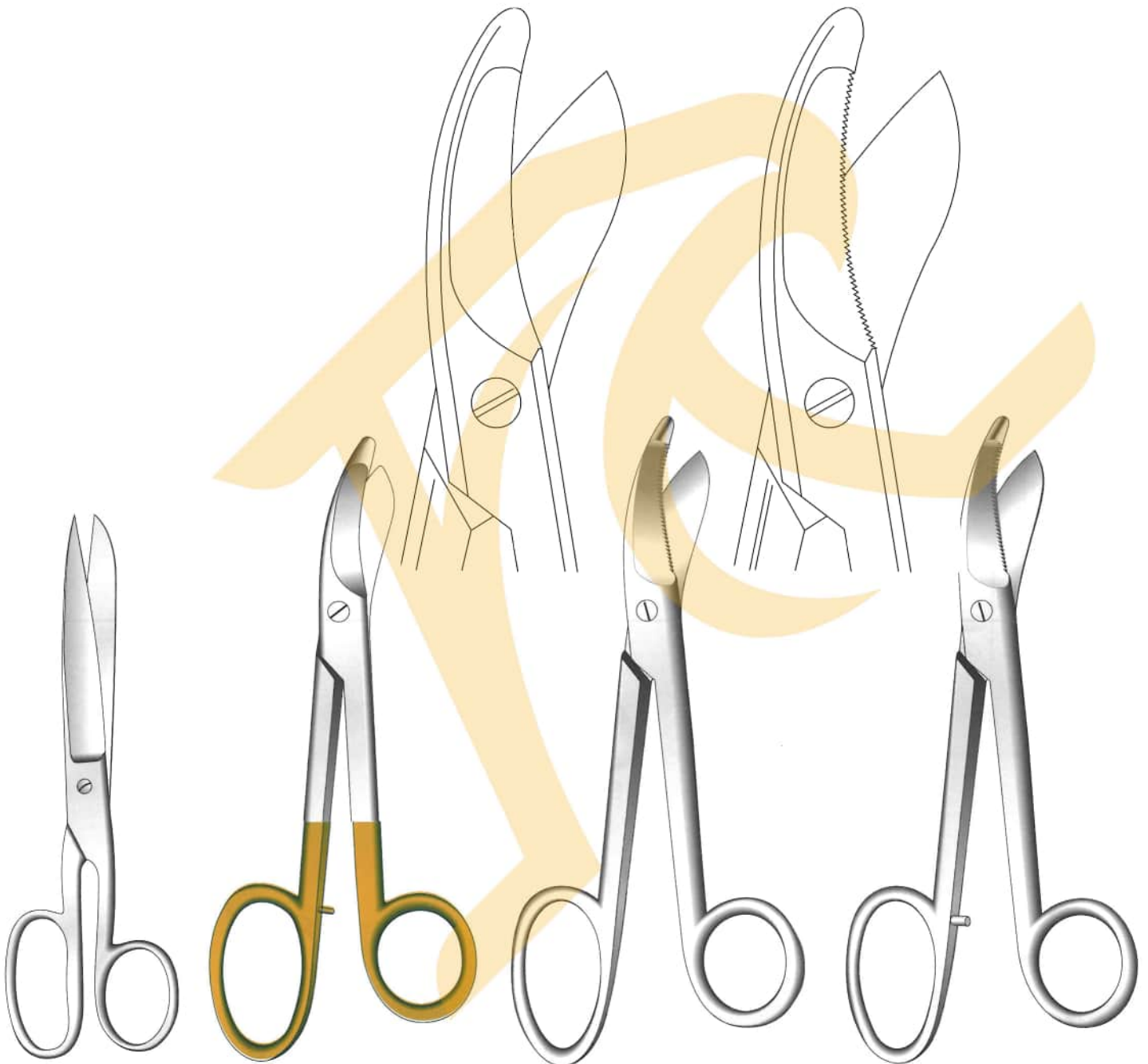

Smith
(Mod. USA)
MO-13-127
20 cm / 8"

Bruns
MO-13-132
23.5 cm / 9 1/4"
T.C. Gold
MT-12-718
24 cm / 9 1/2"
Open shanks with pin

Bruns
MO-13-133
23.5 cm / 9 1/4"
Closed shanks, serrated

Bruns
MO-13-2334
24 cm / 9 1/2"
Open shanks with pin, serrated

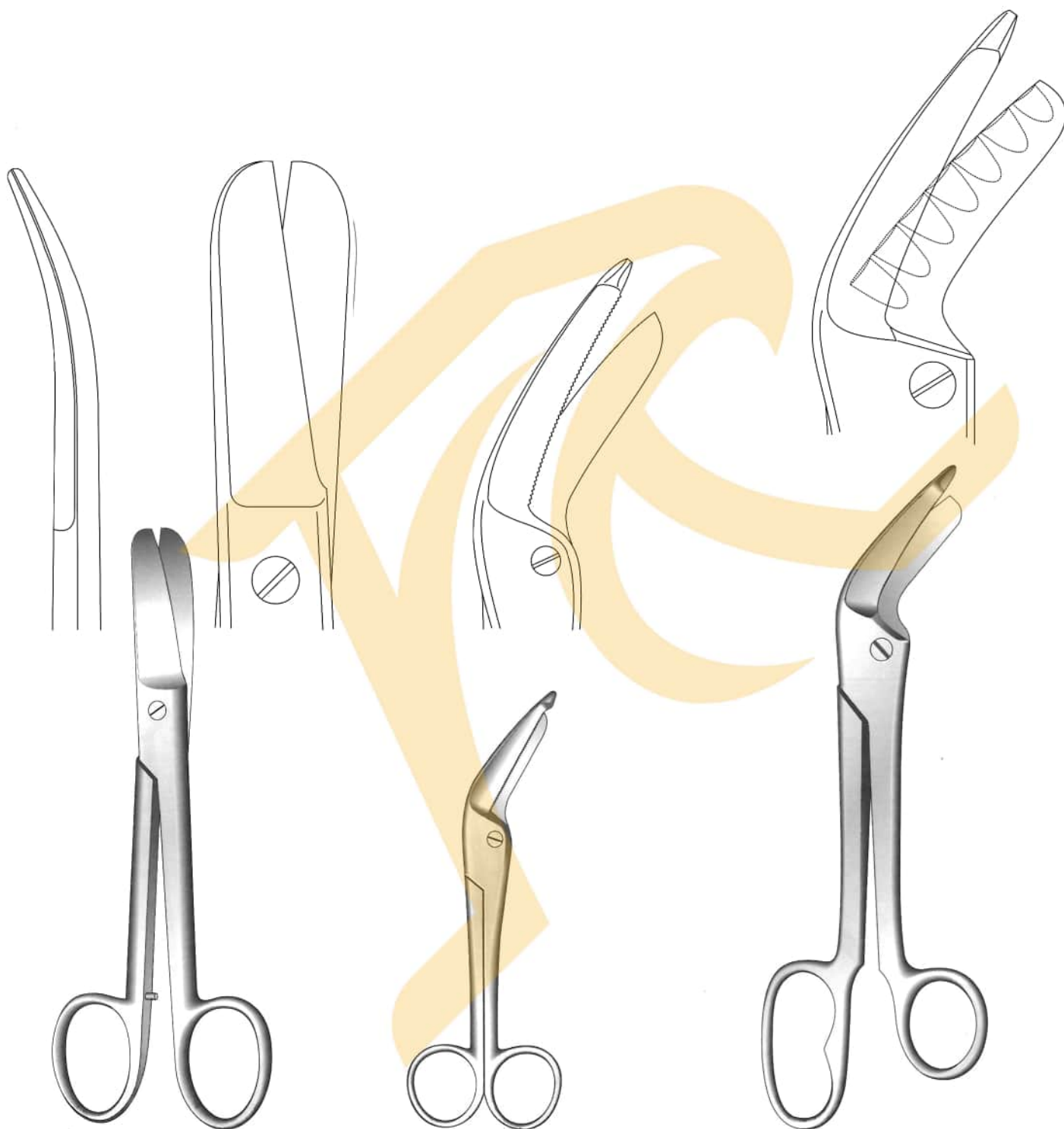

Lorenz
MO-13-128
23 cm / 9"

Excentric
MO-13-129 16 cm / 6¼"
MO-13-130 19 cm / 7½"

Tornado
MO-13-131 24 cm /
9½"
Undulated cutting edge



Seutin
MO-13-134
23 cm / 9"

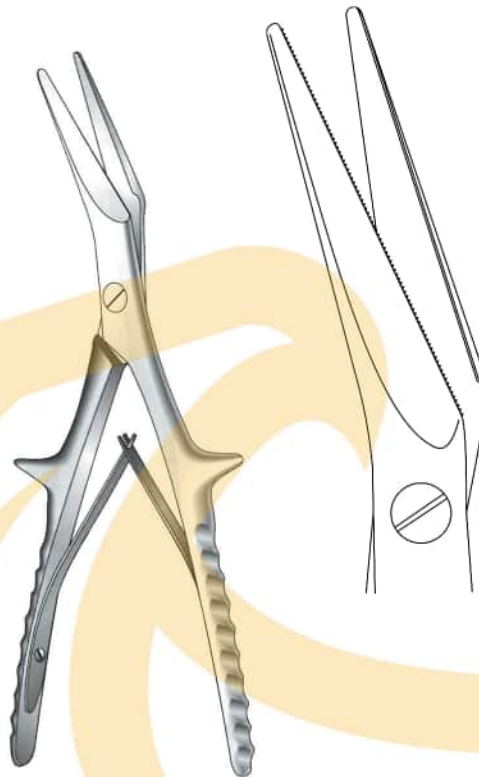

Tessier
MO-13-1500 19.5
cm / 7 3/4"
1 serrated cutting edge

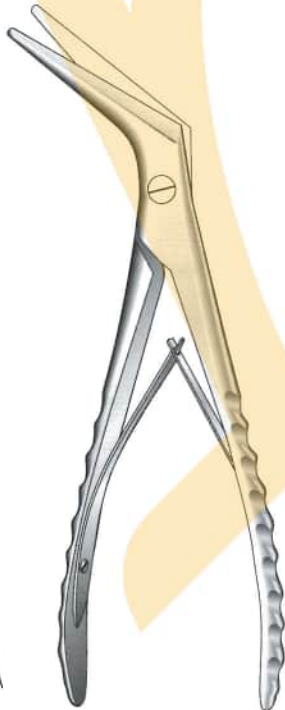
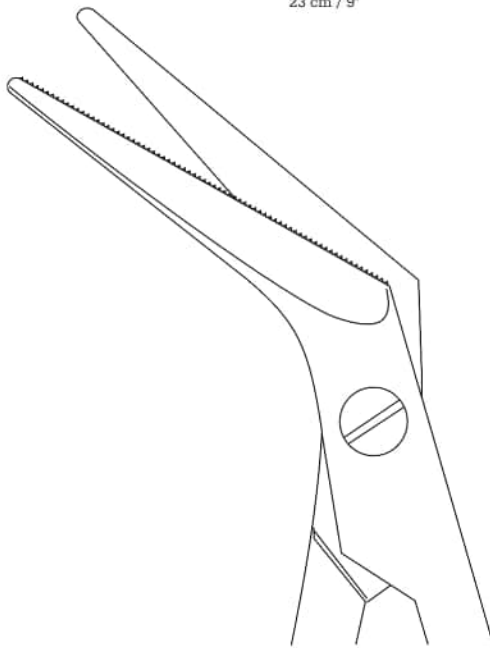

Tessier
MO-13-1505
19 cm / 7 1/2"
1 serrated cutting edge



Universal
MO-13-149
20 cm / 8"

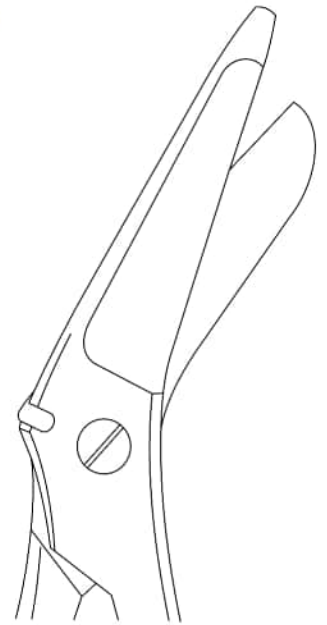

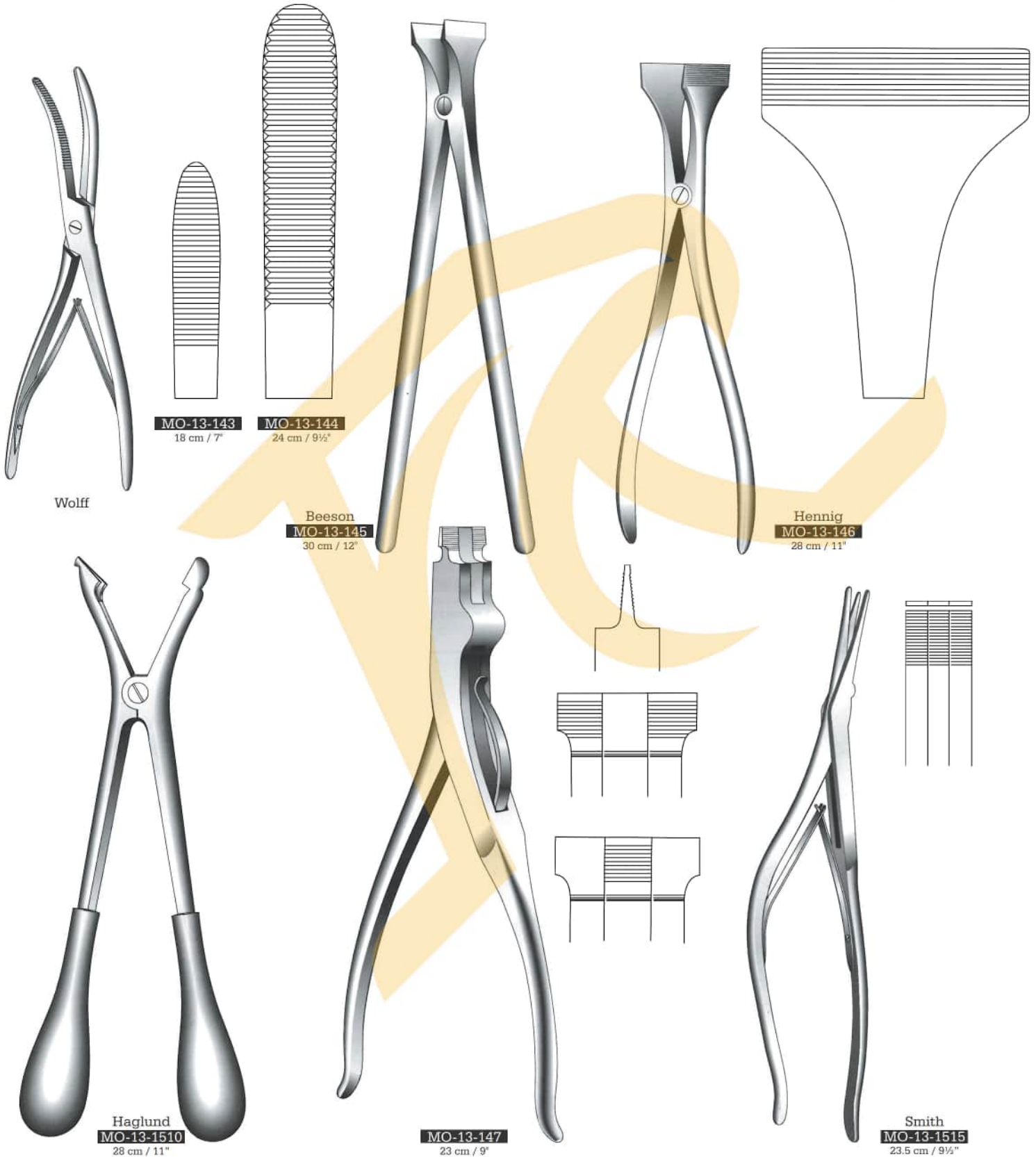

Orthopedic

Plaster-of-Paris Shears

Gippscheren

Cizallas para vendajes enyesados



For lightweight cast breaking and trimming

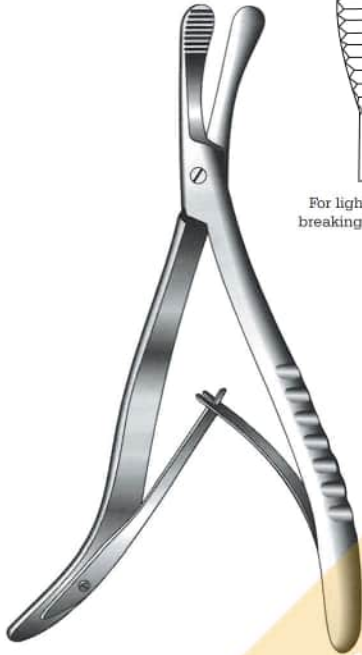

Masson
MO-13-148
18 cm / 7"
Pediatric cast breaker
deep serrated tips



Stille
MO-13-151
24 cm / 9½"



Stille-Mini
MO-13-2200
Blade with reinforced back
MO-13-2201
Blade without reinforced back
20 cm / 8"



Stille

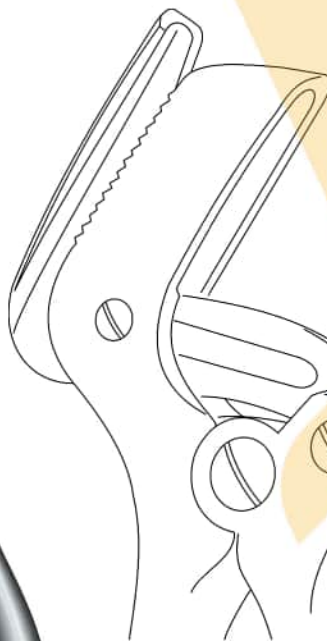

MO-13-153

Blade with reinforced back

MO-13-2202

Blade without reinforced back
23 cm / 9"

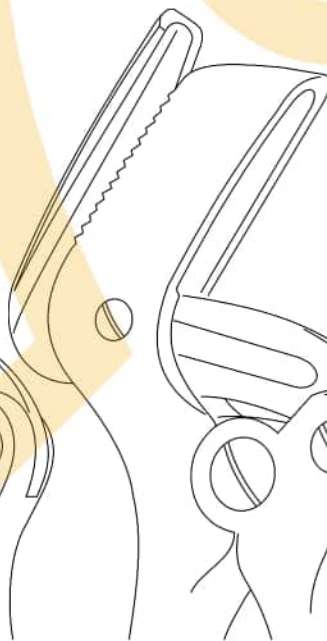

MO-13-154

Blade with reinforced back

MO-13-2203

Blade without reinforced back
26 cm / 10¼"

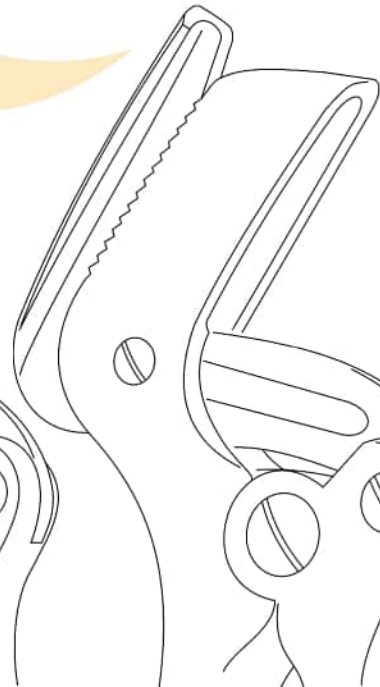

MO-13-155

Blade with reinforced back

MO-13-2204

Blade without reinforced back
37 cm / 14½"



MO-13-156
16.5 cm / 6½"
140 gm / 5 oz, 20 mm Ø



Collin
MO-13-157
20 cm / 8"
220 gm / 7¾ oz, 30 mm Ø



MO-13-158
26 mm Ø
300 gm / 10½ oz

MO-13-159
28 mm Ø
340 gm / 12 oz

MO-13-160
30 mm Ø
400 gm / 14 oz

Williger
24 cm / 9½"



Lucae
19 cm / 7½"

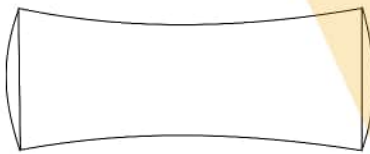

MO-13-161
19 mm Ø
230 gm / 8 oz



MO-13-162
25 mm Ø
260 gm / 9 oz



Doyen
21 cm / 8¼"

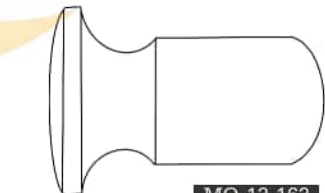

MO-13-163
25 mm Ø
120 gm / 4½ oz

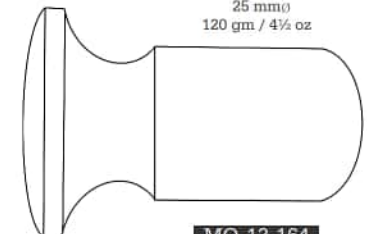

MO-13-164
30 mm Ø
180 gm / 6½ oz

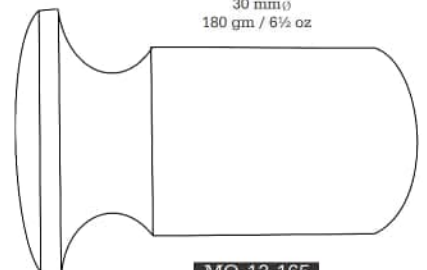

MO-13-165
35 mm Ø
260 gm / 9 oz



Mead
320 gm, 26 mm \emptyset
MO-13-166
Solid
MO-13-167
17 cm / 6 3/4"
Ferrozell faces only,
pair



Partsch
22 mm \emptyset
MO-13-168
18 cm / 7"
200 gm
MO-13-1520
16 cm / 6 1/4" 165
gm
MO-13-1521
18 cm / 7"
220 gm



Heath
MO-13-169
18.5 cm / 7 1/4"
700 gm, 40 mm \emptyset
Cooper filled head



Autoclavable to
250°F (121°C)

Mallet Lightweight
19 cm / 7 1/2"
25 mm \emptyset
MO-13-1525
140 gm
MO-13-170
Two replaceable nylon caps
Total weight: 7 oz.
Head weight: 4 oz



Autoclavable to
250°F (121°C)

Combination Mallet
19 cm / 7 1/2"
MO-13-171
Total weight: 9 oz
Head weight: 5 oz
26 mm \emptyset
MO-13-172
Total weight: 12 oz
Head weight: 8 oz
38 mm \emptyset
One side nylon cap



MO-13-1530
1000 gm
MO-13-1531
700 gm
MO-13-1532
500 gm



Aluminium handle
MO-13-1540
300 gm, 11 oz
MO-13-1545
600 gm, 22 oz
Heavy



Cottle
MO-13-1560
19 cm / 7 1/2" 240
gm, 30 mm \emptyset



Gerzog
MO-13-1550
18 cm / 7"
250 gm



Kirk
MO-13-1555
19 cm / 7½"
750 gm

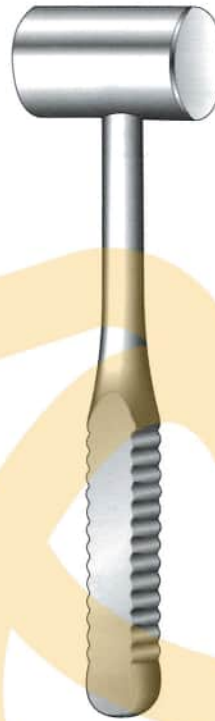

Ombredanne
MO-13-1565
24 cm / 9½"
550 gm, 40 mm Ø



Bergmann
MO-13-1570
24.5 cm / 9¾"
300 gm, 45 mm Ø



Bergmann
MO-13-1575
23.5 cm / 9¼"
300 gm, 30 mm Ø



Wagner
MO-13-1580
23.5 cm / 9¼"
35 mm Ø



Metal head
MO-13-1581
230 gm, 35 mm Ø



Plastic head
MO-13-1582
32 gm, 35 mm Ø



Quisling
MO-13-1585



MO-13-1590
23.5 cm / 9¼"



MO-13-173 450 gm
MO-13-176 900 gm
26 cm / 10 1/2"



MO-13-175
26 cm / 10 1/2"
510 gm / 18 oz
30 mm Ø

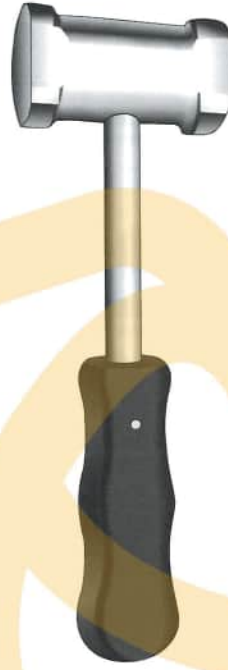

MO-13-2210
Head weight 550 gm
Total weight 760 gm
40 mm Ø



MO-13-2215
Head weight 350 gm
Total weight 550 gm
35 mm Ø



MO-13-2220
Head weight 300 gm
30 mm Ø



MO-13-2225
Head weight 300 gm
Total weight 500 gm
30 mm Ø



MO-13-2230
Medium size hammer
Full aluminum
Total weight 200 gm



MO-13-2235
Small hammer aluminum handle
with stainless steel head
with rubber side (changeable)
Total weight 125 gm

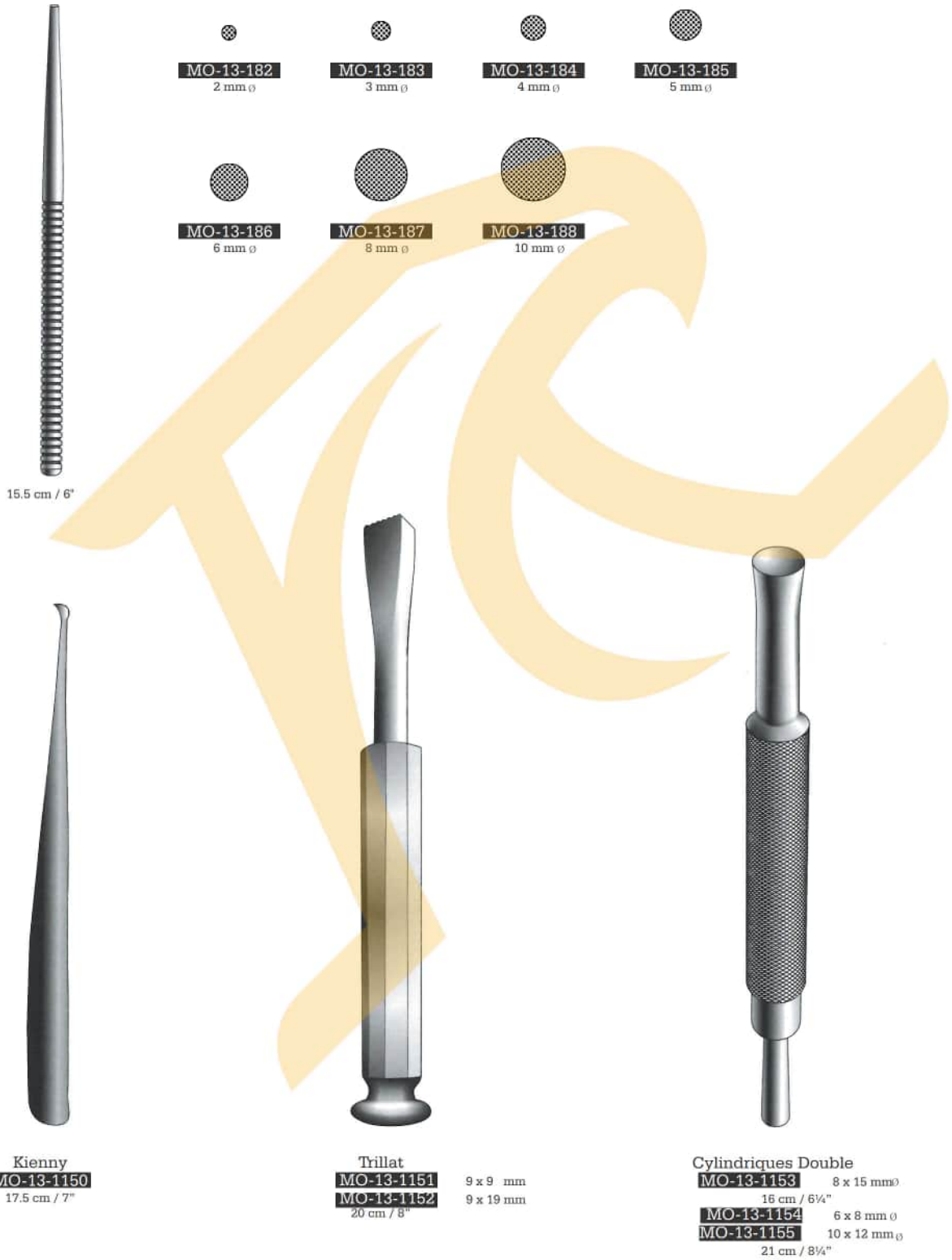

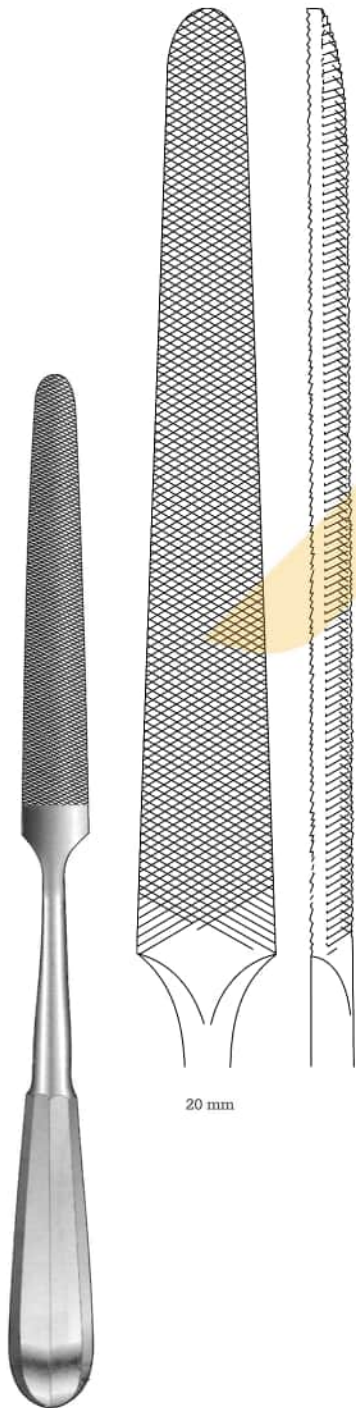

MO-13-177
28 cm / 11"

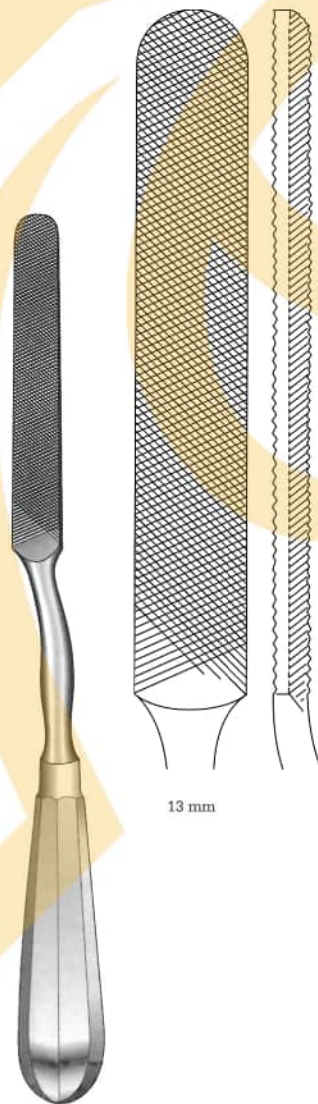

MO-13-178
24.5 cm / 9 3/4"

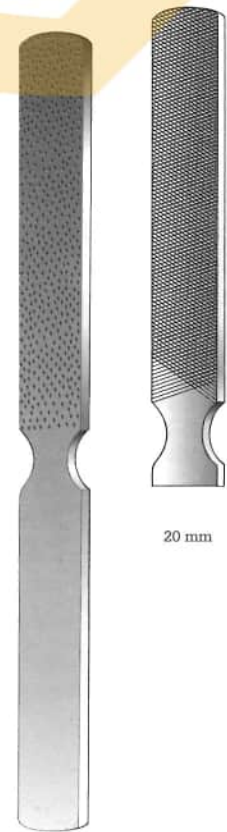

MO-13-179
22 cm / 8 3/4"



Putti
MO-13-180
30 cm / 12"



Putti
MO-13-181
27 cm / 10 1/2"



Fomon
MO-13-189
21 cm / 8 1/4"
Double ended, fine and coarse teeth 4-side, convex and flat blades 8 mm width



Murphy-Lane
MO-13-2170
30 cm / 12"
Bone skid



Orthopedic

Nasal Rasp, Bone Files

Nasenraspein, Knochenfeile

Escofinasnasales, Lima Para Huesos

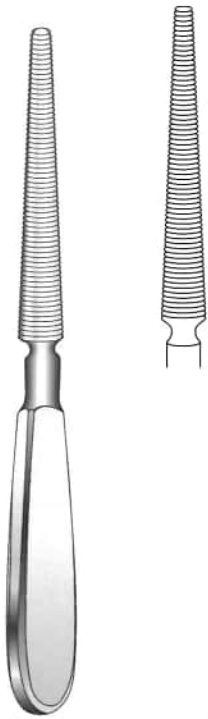

Trochlear
MO-13-1136
17 cm / 6½"
Stainless steel



Maltz Improved
MO-13-190
21 cm / 8¼"
Double ended, forward and backward cutting, 8 mm width



Aufrecht
21 cm / 8¼"

MO-13-191
Single ended
forward cutting
9 mm width

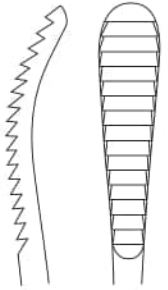

MO-13-192
Single ended
backward cutting
9 mm width



Maltz
18 cm / 7"
Single ended
10 mm width

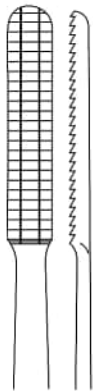

MO-13-193
34 x 7 mm
Backward cutting

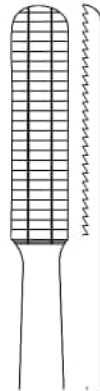

MO-13-1541
34 x 7 mm
Forward cutting



Excision Arthroplasty
MO-13-1137
17 cm / 6½"
Stainless steel



Joseph
MO-13-194
16 cm / 6¼"
Single ended, 8 mm at wide point, fine cross serrations



MO-13-195
Fine, single ended
8 mm width

MO-13-196
Coarse, single ended
8 mm width
plain serrations

Lewis Rasp
19 cm / 7½"

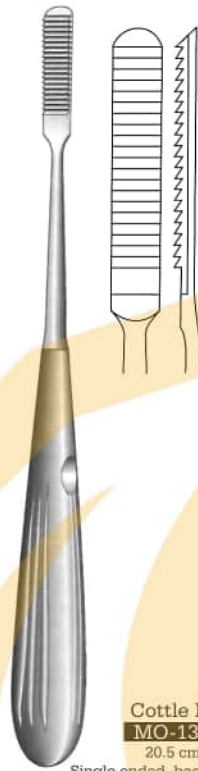

Cottle Rasp
MO-13-197
20.5 cm / 8"
Single ended, backward cutting
9 mm width
plain serrations

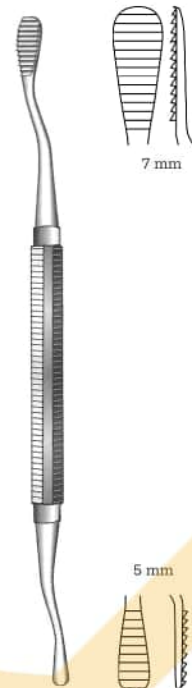

Miller-Colburn
MO-13-198
18 cm / 7"
Double ended, plain serrations

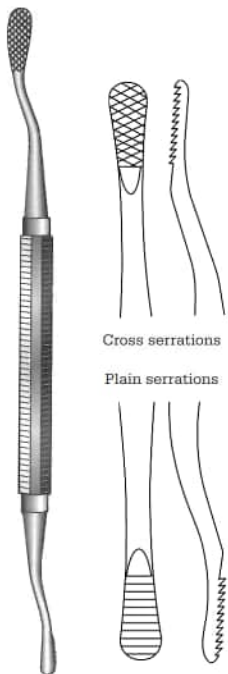

Cross serrations
Plain serrations

Miller-Colburn
MO-13-199
18 cm / 7"
Double ended, 5 mm width

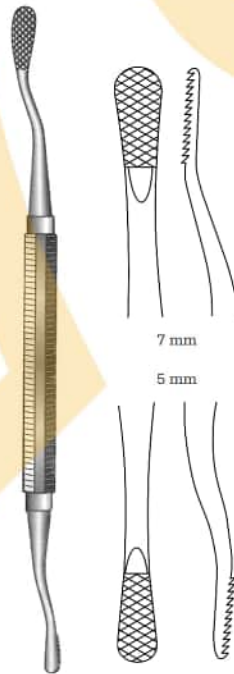

7 mm
5 mm

Miller-Colburn
MO-13-200
18 cm / 7"
Double ended, cross serrations

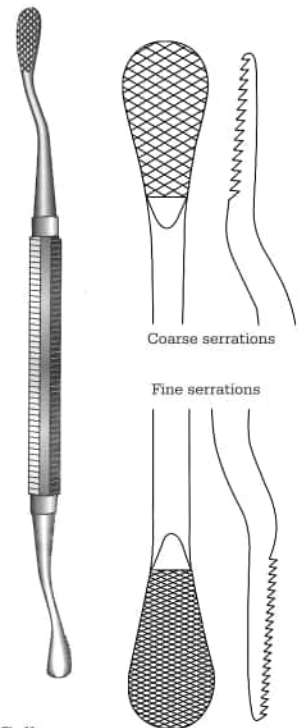

Coarse serrations
Fine serrations

Miller-Colburn
MO-13-201
21.5 cm / 8½"
Double ended, 13 mm width
Cross serrations, for rapid shaping of bone

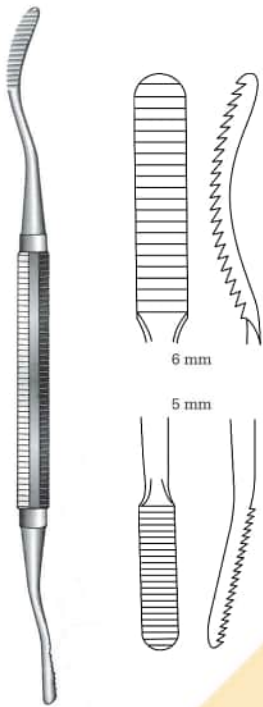

Miller-Colburn
MO-13-202
 18.5 cm / 7 1/4"
 Double ended, plain serrations

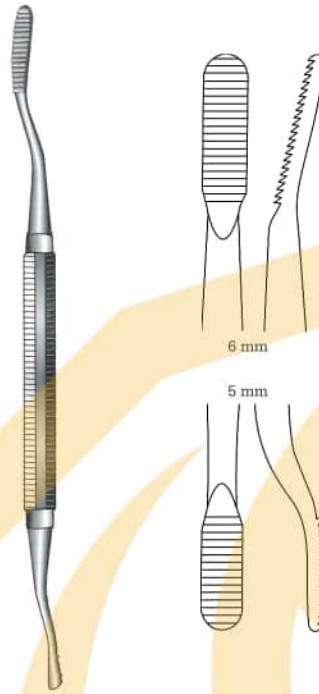

Miller-Colburn
MO-13-203
 18 cm / 7"
 Double ended, plain serrations

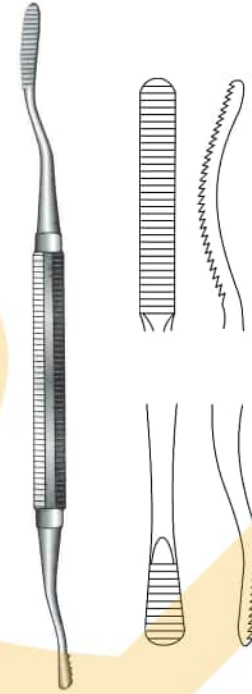

Miller-Colburn
MO-13-204
 18 cm / 7"
 Double ended, 5 mm width,
 plain serrations



Polokoff Rasp
 Double ended, plain serrations

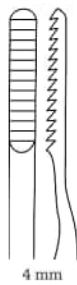

MO-13-205
 18 cm / 7"

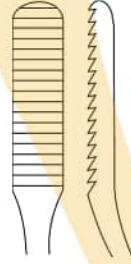

MO-13-206
 21.5 cm / 8 1/2"
 6 mm width

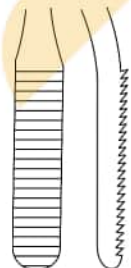

Miller-Colburn
MO-13-207
 18 cm / 7"
 Double ended

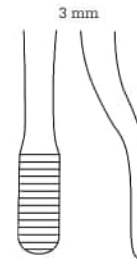
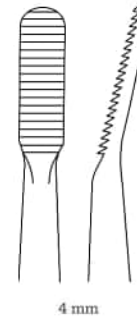

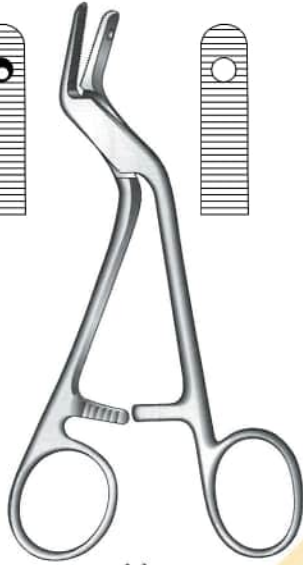
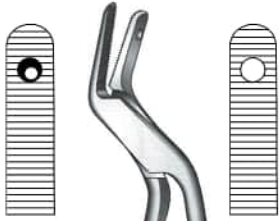

Adson
MO-13-208
 15 cm / 6" Drill
 guide

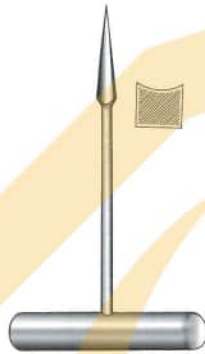

MO-13-209
 14 cm / 5 1/2"

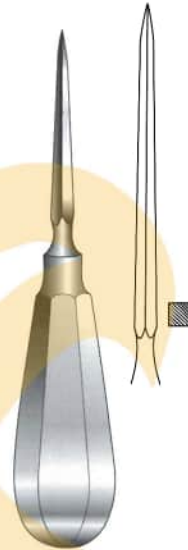

MO-13-210
 14 cm / 5 1/2"



MO-13-2270
 30 cm / 12"
 Straight ball spike



Perthes
MO-13-1595
 18 cm / 7"

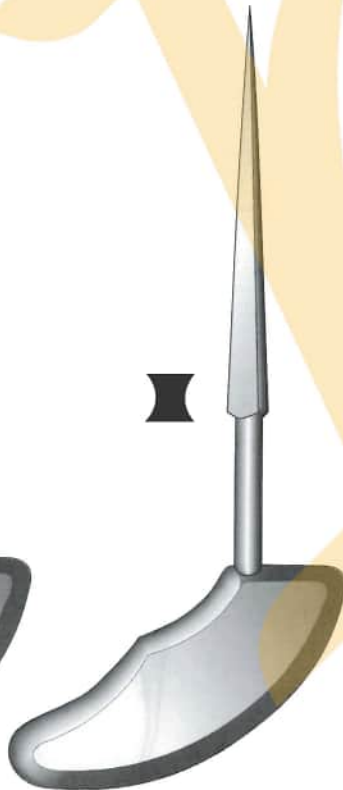

Perthes
MO-13-211
 21 cm / 8 1/4"

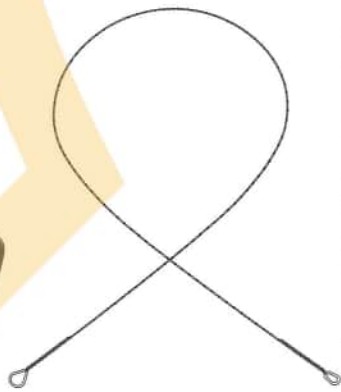

Olivecrona
MO-13-212 30 cm / 12"
MO-13-213 40 cm / 16"
MO-13-214 50 cm / 20"
MO-13-215 70 cm / 28"

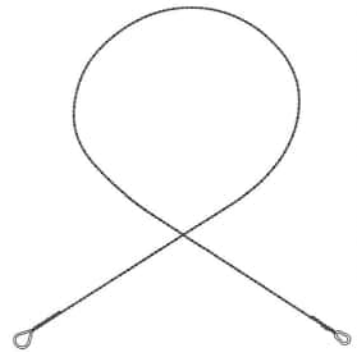

Gigli
MO-13-216 30 cm / 12"
MO-13-217 40 cm / 16"
MO-13-218 50 cm / 20"
MO-13-219 50 cm / 20"
 Fine, 6 wires twisted



Orthopedic

Amputating, Resection Saws & Handles
Amputation, Resektionssagen und griffe
Amputaion, Sierras Para Reseooion Y Mangos



Gigli
MO-13-220
Handle

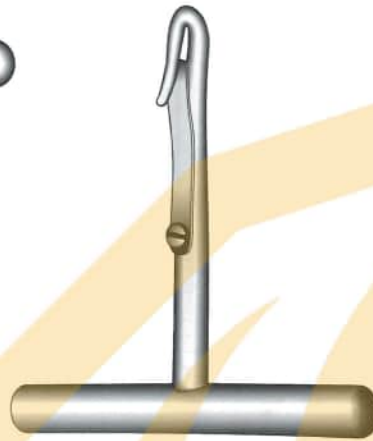

Gigli
MO-13-1600
Handle with lock



Engel
MO-13-104



Lindemann
MO-13-221
20 cm / 8"



Langenbeck
MO-13-222
23 cm / 9"



Charriere
MO-13-223
35 cm / 14"



Charriere
MO-13-2500 27 cm / 10½"
MO-13-2501 30 cm / 12"
MO-13-2502 34 cm / 13½"



Satterlee
MO-13-225
Blade 23 cm / 9"



MV-0651-30
 30 cm / 11 3/4"
 Blade 20 cm
 Post mortem saw



Butcher
MV-0010-00
 Blade 45 cm
 Post mortem saw



MV-0653-00
 Blade 40 cm
 Post mortem saw



Bier
MO-13-226 42 cm /
 16 1/2"
 Length of blade 27 cm /
 10 1/2"
 Complete with one saw
 blade each 4 mm, 6 mm, 8
 mm

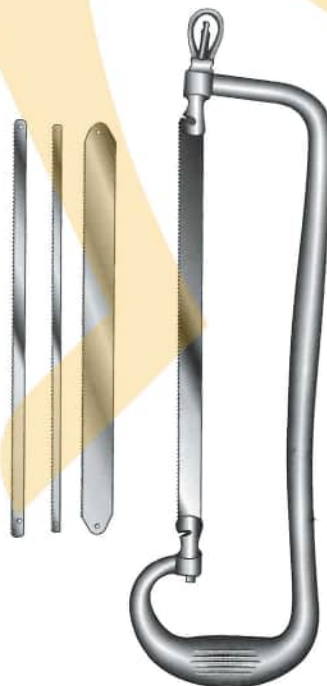

Rust
MO-13-230 39 cm /
 15 1/2"
 Length of blade
 Complete with one saw
 blade each 8 mm, 12 mm

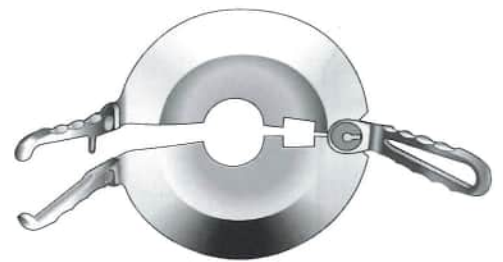

Percy
MO-13-231



Hudson
MO-13-233
Extension Piece



MO-13-234
9 mm \varnothing
Conical Burr



MO-13-235
14 mm \varnothing
Conical Burr



MO-13-236
16 mm \varnothing
Spherical Burr



MO-13-237
22 mm \varnothing
Spherical Burr



Hudson
27 cm / 10 $\frac{3}{4}$ "
MO-13-232
Complete set with Stainless steel handles
MO-13-2510
Complete set with Ferrozell handles
MO-13-2515
Complete set with Teflon handles



MO-13-238
14 mm \varnothing
Flat Trophine



MO-13-239
2 mm \varnothing
Twist Drill



MO-13-240
13 mm \varnothing
Burr



MO-13-241
16 mm \varnothing
Burr



Hudson
27 cm / 10 $\frac{3}{4}$ "
MO-13-2520
Brace only with Stainless steel handles
MO-13-2521
Brace only with Ferrozell handles
MO-13-2522
Brace only with Teflon handles

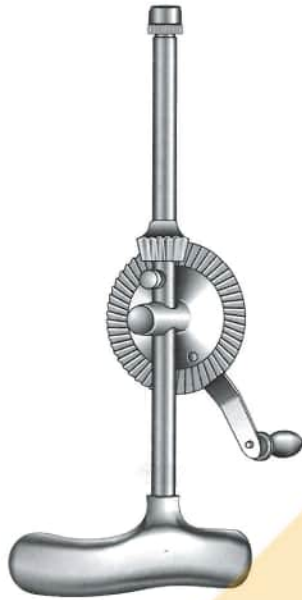

Stille-Sherman
MO-13-242
24 cm / 9½"
MO-13-1742
Complete set



MO-13-243
2.5 mm \varnothing
Twist Drill



MO-13-244
3 mm \varnothing
Twist Drill



MO-13-245
3.5 mm \varnothing
Twist Drill

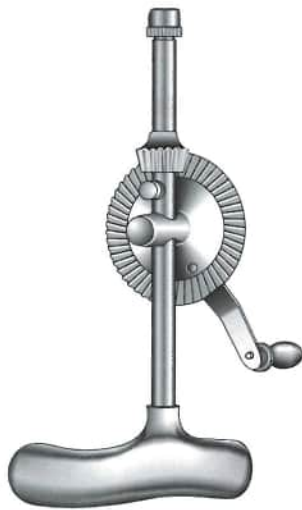

Stille
MO-13-246
20 cm / 8"
MO-13-1746
Complete set



MO-13-247
2.5 mm \varnothing
Twist Drill



MO-13-248
3 mm \varnothing
Twist Drill



MO-13-249
3.5 mm \varnothing
Twist Drill



MO-13-250
4 mm \varnothing
Twist Drill



MO-13-251
10 mm \varnothing
Trepine



MO-13-252
5 mm \varnothing
Spherical Burr



MO-13-253
8 mm \varnothing
Spherical Burr



MO-13-254
12 mm \varnothing
Spherical Burr



MO-13-255
16 mm \varnothing
Spherical Burr



MO-13-256
1 mm \varnothing
Twist Drill



MO-13-257
1.5 mm \varnothing
Twist Drill



MO-13-258
2 mm \varnothing
Twist Drill



MO-13-264

Handle with chuck and key, accomodating up to 6.35 mm (1/4"), perforated, for inserting and extracting nails, guide pins and wire guide drills.



MO-13-2535
Key only

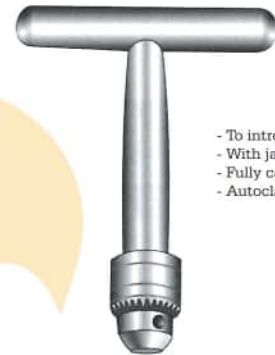

Pin Chuck
MO-13-2530 6.35 mm
 15 cm / 6"
MO-13-2531 4.50 mm
 14 cm / 5 1/2"

- To introduce bone pin
- With jacob chuck
- Fully cannulated
- Autoclaveable



MO-13-1156



Moore
MO-13-262



MO-13-2540
 9 cm
 3.2 mm ϕ



MO-13-2541
 7 cm
 3.2 mm ϕ

MO-13-263
 Complete with a set of
 twist drill ref:
 JO-21-2540, JO-21-2541

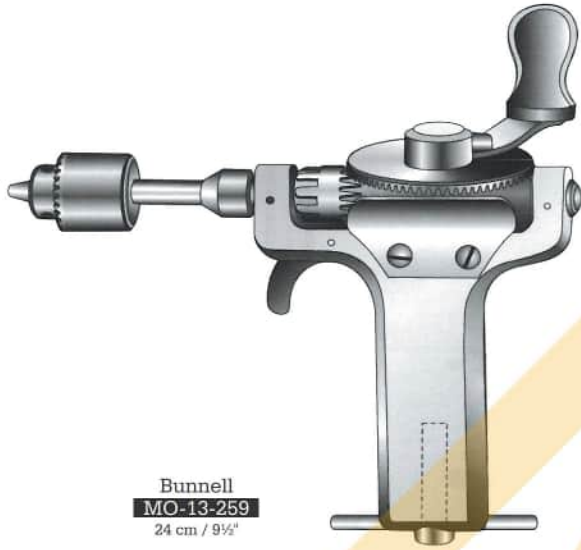

Bunnell
MO-13-259
24 cm / 9½"

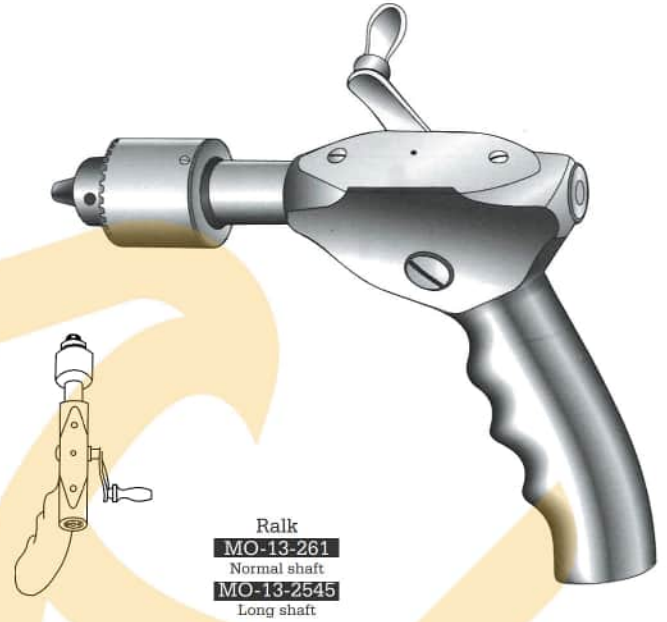

Ralk
MO-13-261
Normal shaft
MO-13-2545
Long shaft



Jacobs
MO-13-3200 Small
MO-13-3205 Large
Stainless steel



MO-13-3210
Key for Jacobs chuck
Stainless steel



MO-13-3215 Small
MO-13-3220 Large
Chrome plated
MO-13-3225 Small
MO-13-3230 Large
Stainless steel



MO-13-3235
Key for chuck

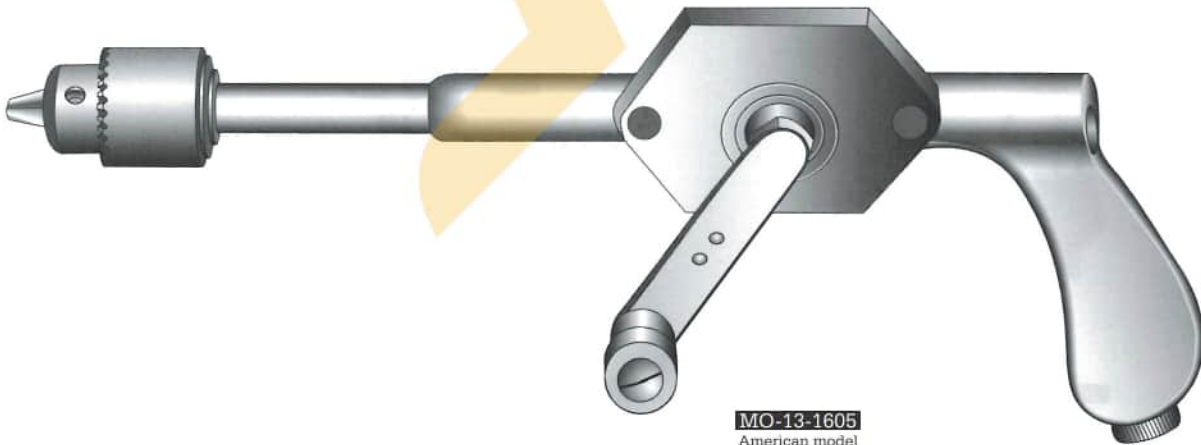

MO-13-1605
American model



Williams
MO-13-2550
24 cm / 9 1/2"

Lane
MO-13-2565
25 cm / 10"
Ferrozell handle

Hexagon
MO-13-2580
17 cm / 6 3/4"
Ferrozell handle

Hexagon
MO-13-2585
17 cm / 6 3/4"
Ferrozell handle

Hexagon
MO-13-2590
17 cm / 6 3/4"
Ferrozell handle

Hexagon
MO-13-2600
18 cm / 7"
1.5 mm tip
With sleeve

MO-13-2560
17 cm / 6 3/4"
Ferrozell handle

MO-13-2570
17 cm / 6 3/4"
Ferrozell handle

MO-13-2571
25 cm / 10"
Ferrozell handle

MO-13-2575
17 cm / 6 3/4"
Ferrozell handle

MO-13-2576
25 cm / 10"
Ferrozell handle

MO-13-2581
25 cm / 10"
Ferrozell handle

MO-13-2586
25 cm / 10"
Ferrozell handle

MO-13-2591
25 cm / 10"
Ferrozell handle

MO-13-2610
Sleeve only

MO-13-2605
2.5 mm

MO-13-2606
3.5 mm

MO-13-2607
4.5 mm

2.5 mm

3.5 mm

4.5 mm



MO-13-1160
MO-13-1161

For children
For adults

Orthopedic

Nail Instruments, Finger Ring Saws

Instrumente Für Finger-und Zehennagel, Fingerringsagen

Instrumentos Para Unas, Sierras Para Abrir Anillos



MO-13-271
17 cm / 6 3/4"
Ring cutter



Walton
MO-13-272
16 cm / 6 1/4"
MO-13-2000
Spare blade for ring cutters



MO-13-273
17 cm / 6 3/4"
Ring cutter

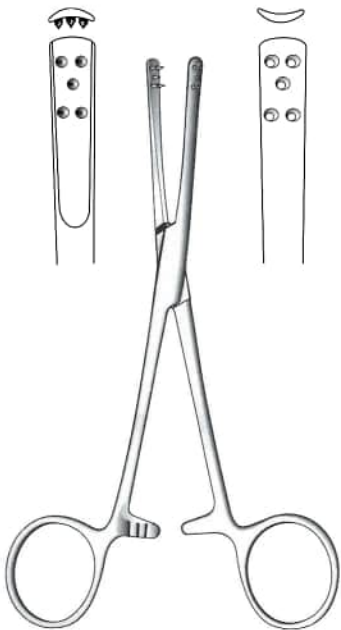

Penner
MO-13-274
15.5 cm / 6"



Radolf
MO-13-275
13.5 cm / 5 1/4"



MO-13-2614
14.5 cm / 5 3/4"
Nail extracting forceps



Coupe Clamp
MO-13-2615
14 cm / 5 1/2"
Plastic



MO-13-277
 Fig. 00/0

MO-13-278
 Fig. 0/1

MO-13-279
 Fig. 1/2

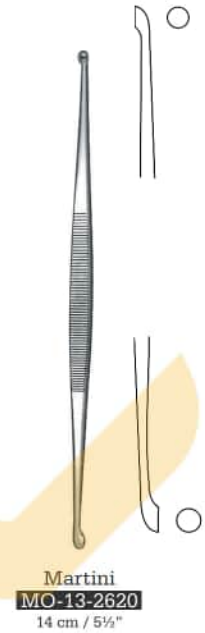

Volkman

MO-13-280
 13 cm / 5"

MO-13-281
 14 cm / 5 1/2"

MO-13-282
 17 cm / 6 3/4"



Volkman

MO-13-283
 13 cm / 5"

MO-13-284
 16 cm / 6 1/4"

MO-13-285
 20 cm / 8"



Volkman
 17 cm / 6 3/4"

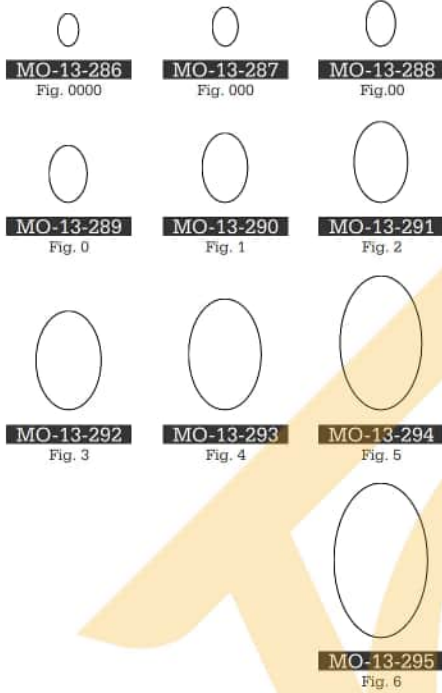

Spratt
 17 cm / 6 3/4"

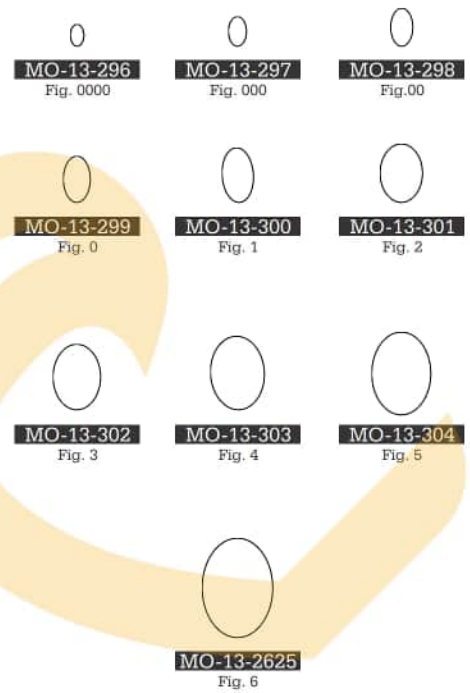

Bruns
 17 cm / 6 3/4"

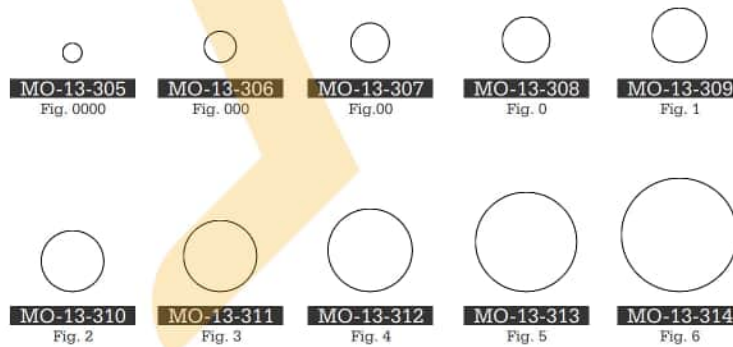



Scheide



MO-13-315
Fig. 000



MO-13-316
Fig.00



MO-13-317
Fig. 0



MO-13-318
Fig. 1



MO-13-319
Fig. 2



MO-13-320
Fig. 3



MO-13-321
Fig. 4



MO-13-322
Fig. 00



MO-13-323
Fig. 00



MO-13-324
Fig. 0



MO-13-325
Fig. 0



MO-13-326
Fig. 1



MO-13-327
Fig. 1



MO-13-328
Fig. 2



MO-13-329
Fig. 2



MO-13-339



MO-13-340



MO-13-341



Williger
17.5 cm / 7"



25 cm / 9 3/4"



JO-21-342
Fig. 1

MO-13-348
Fig. 1

MO-13-349
Fig. 2

MO-13-350
Fig. 3

MO-13-351
Fig. 4

MO-13-352
Fig. 5

MO-13-353
Fig. 6

MO-13-344
Fig. 3

MO-13-354
Fig. 1

MO-13-355
Fig. 2

MO-13-356
Fig. 3

MO-13-345
Fig. 4

MO-13-357
Fig. 4

MO-13-358
Fig. 5

MO-13-359
Fig. 6

MO-13-346
Fig. 5

MO-13-360
Fig. 1

MO-13-361
Fig. 2

MO-13-362
Fig. 3

MO-13-347
Fig. 6

MO-13-363
Fig. 4

MO-13-364
Fig. 5

MO-13-365
Fig. 6

JO-21-366
Fig. 1

JO-21-367
Fig. 2

JO-21-368
Fig. 3

Simon
24 cm / 9 1/2"

Mod. USA
16 cm / 6 1/4"

Halle
21 cm / 8 1/4"

Manufacturer	Model Number	Figure	Tip Description	
Volkmann 17 cm / 6 3/4" Ferozell handle	MO-13-369	Fig. 0000	Straight	
	MO-13-371	Fig. 000	Straight	
	MO-13-373	Fig. 00	Straight	
	MO-13-375	Fig. 0	Straight	
	MO-13-377	Fig. 1	Straight	
	MO-13-370	Fig. 2	Straight	
	MO-13-372	Fig. 3	Straight	
	MO-13-374	Fig. 4	Straight	
	MO-13-376	Fig. 5	Straight	
	MO-13-378	Fig. 6	Straight	
	Volkmann 27 cm / 10 1/4" Ferozell handle	MO-13-379	Fig. 0	Straight
		MO-13-380	Fig. 1	Straight
		MO-13-381	Fig. 2	Straight
		MO-13-382	Fig. 3	Straight
MO-13-383		Fig. 4	Straight	
Brun 23 cm / 9" With solid hexagonal handle		MO-13-384	Fig. 000 45°	Straight Angled
		MO-13-385	Fig. 00 45°	Straight Angled
		MO-13-386	Fig. 0	Straight Angled 45°
		MO-13-387	Fig. 1	Straight Angled 45°
		MO-13-388	Fig. 2	Straight Angled 45°
		MO-13-389	Fig. 3	Straight Angled 45°
		MO-13-390	Fig. 4	Straight Angled 45°
		MO-13-391	Fig. 5	Straight Angled 45°
		MO-13-392	Fig. 6	Straight Angled 45°
	Cobb 28 cm / 11" Knurled handle Stainless steel	MO-13-402	Fig. 000 45°	Straight Angled
		MO-13-403	Fig. 00 45°	Straight Angled
		MO-13-404	Fig. 0	Straight Angled 45°
		MO-13-405	Fig. 1	Straight Angled 45°
		MO-13-406	Fig. 2	Straight Angled 45°
MO-13-407		Fig. 3	Straight Angled 45°	
MO-13-408		Fig. 4	Straight Angled 45°	
MO-13-409		Fig. 5	Straight Angled 45°	
MO-13-410		Fig. 6	Straight Angled 45°	

Orthopedic

Bone Osteotomes Chisels And Gouges

Meißel Und Osteotome

Cinceles Y Gubias Para Huesos



13.5 cm / 5 1/4"
Osteotomes

MO-13-420	8 mm
MO-13-421	10 mm
MO-13-422	12 mm
MO-13-423	14 mm
MO-13-424	16 mm

13.5 cm / 5 1/4"
Chisels

MO-13-425	8 mm
MO-13-426	10 mm
MO-13-427	12 mm
MO-13-428	14 mm
MO-13-429	16 mm

13.5 cm / 5 1/4"
Gouges

MO-13-430	8 mm
MO-13-431	10 mm
MO-13-432	12 mm
MO-13-433	14 mm
MO-13-434	16 mm

Gillies

MO-13-435	5 mm
MO-13-436	7 mm
MO-13-437	9 mm

14 cm / 5 1/2"
Osteotomes

Partsch



































MO-13-438	3 mm
MO-13-439	4 mm
MO-13-440	5 mm
MO-13-441	6 mm
MO-13-442	7 mm

17 cm / 6 3/4"
Chisels

Partsch

MO-13-443	3 mm
MO-13-444	4 mm
MO-13-445	5 mm
MO-13-446	6 mm
MO-13-447	7 mm

17 cm / 6 3/4"
Gouges

						
	MO-13-448 13.5 cm / 5¼" 2 mm	MO-13-449 17 cm / 6¾" 2 mm		MO-13-458 13.5 cm / 5¼" 2 mm	MO-13-459 17 cm / 6¾" 2 mm	
						
	MO-13-450 13.5 cm / 5¼" 3 mm	MO-13-451 17 cm / 6¾" 3 mm		MO-13-460 13.5 cm / 5¼" 3 mm	MO-13-461 17 cm / 6¾" 3 mm	
						
	MO-13-452 13.5 cm / 5¼" 4 mm	MO-13-453 17 cm / 6¾" 4 mm		MO-13-462 13.5 cm / 5¼" 4 mm	MO-13-463 17 cm / 6¾" 4 mm	
						
MO-13-454 13.5 cm / 5¼" 5 mm	MO-13-455 17 cm / 6¾" 5 mm		MO-13-464 13.5 cm / 5¼" 5 mm	MO-13-465 17 cm / 6¾" 5 mm		
						
	MO-13-456 13.5 cm / 5¼" 6 mm	MO-13-457 17 cm / 6¾" 6 mm		MO-13-466 13.5 cm / 5¼" 6 mm	MO-13-467 17 cm / 6¾" 6 mm	
						
	MO-13-468 4 mm	MO-13-469 6 mm	MO-13-470 8 mm		MO-13-474 4 mm	MO-13-475 6 mm
						
MO-13-471 10 mm	MO-13-472 12 mm	MO-13-473 14 mm		MO-13-477 10 mm	MO-13-478 12 mm	
						
				MO-13-476 8 mm	MO-13-479 14 mm	
Alexander 18 cm / 7" Chisels				Alexander 18 cm / 7" Gouge		

Orthopedic

Bone Osteotomes Chisels And Gouges

Meibel Und Osteotome

Cinceles Y Gubias Para Huesos



Lucas
MO-13-480 4 mm
MO-13-481 6 mm
 16 cm / 6 1/4"



Lucas
MO-13-482 3 mm
MO-13-483 5 mm
 16 cm / 6 1/4"



Cottle
MO-13-484 4 mm
MO-13-485 6 mm
MO-13-486 8 mm
MO-13-487 10 mm
MO-13-488 12 mm
 18 cm / 7"
 With depth markings



Cottle
MO-13-489 4 mm
MO-13-490 7 mm
MO-13-491 9 mm
MO-13-492 12 mm
 18 cm / 7"
 With depth markings

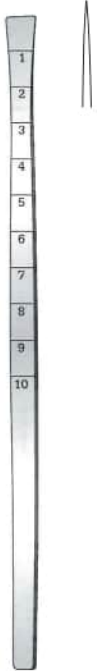

Cottle
MO-13-493
 18 cm / 7"
 8 mm

Fishtail chisel, with protected ends



East Grinstead (Ward)
MO-13-494 3 mm
MO-13-495 5 mm
 18 cm / 7"



Eastmann
MO-13-496 3 mm
MO-13-497 5 mm
 19 cm / 7 1/2"



East Grinstead (Ward)
MO-13-498 3 mm
MO-13-499 5 mm
 18 cm / 7"

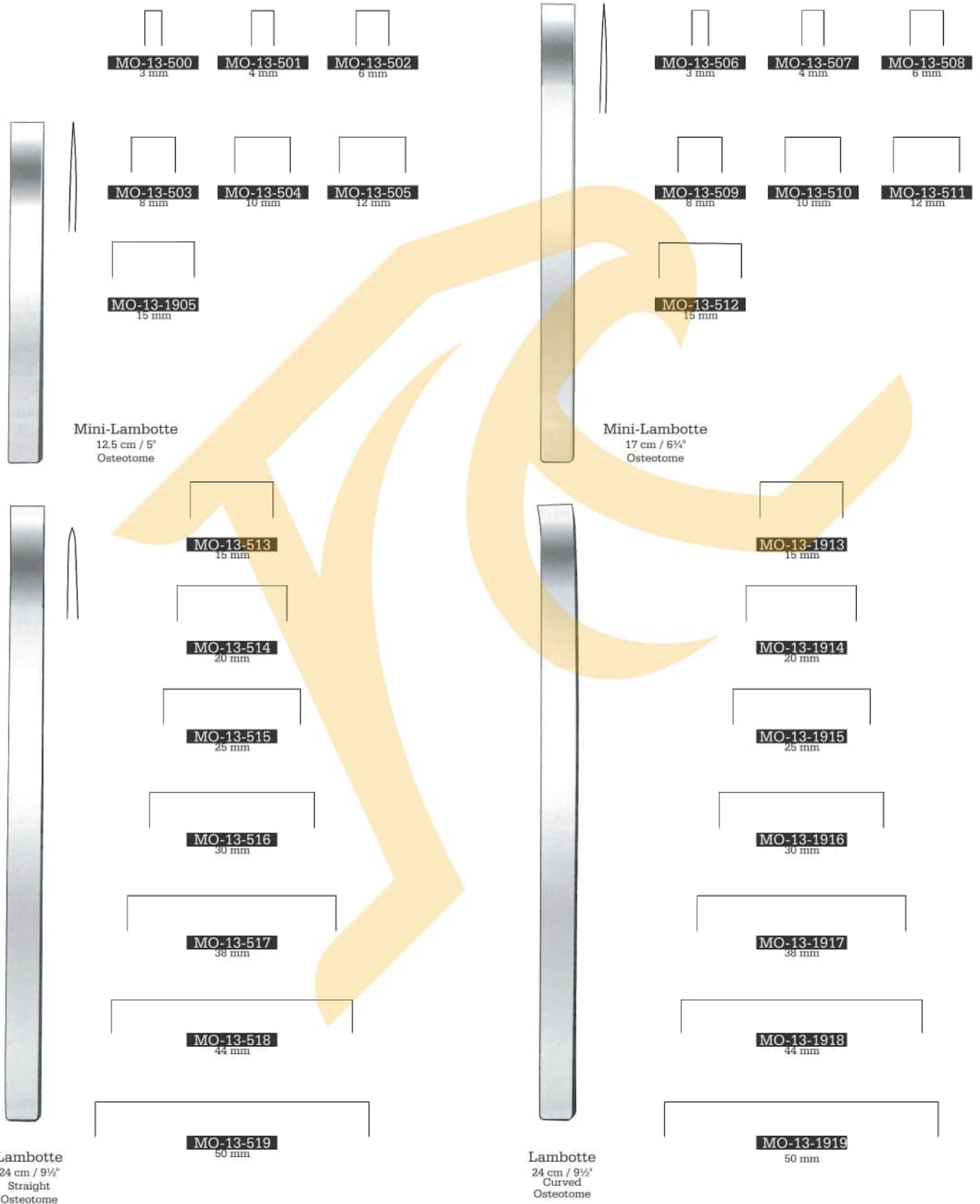



Tessier
 20 cm / 7 3/4"

For taking grafts from ilium and tibia

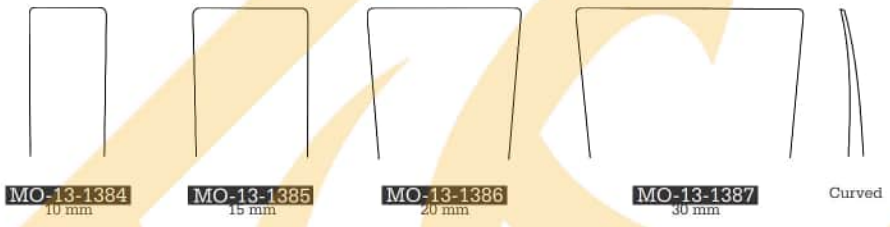
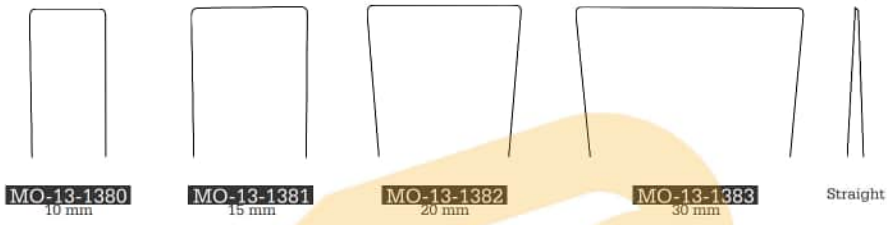

Tessier
 16 cm / 6 1/4"

For taking grafts from the calva

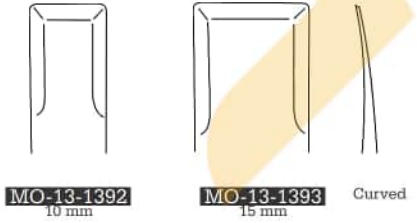
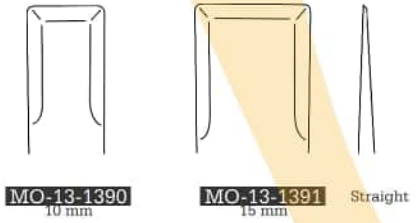

Key
 MO-13-1388 19 cm / 7 1/2"
 MO-13-1389 21 cm / 8 1/4"
 Periosteal elevator



Stille

MO-13-521	10 mm
MO-13-522	12 mm
MO-13-523	15 mm
MO-13-524	20 mm
MO-13-525	25 mm

20.5 cm / 8"
Chisels



Stille

MO-13-526	10 mm
MO-13-527	12 mm
MO-13-528	15 mm
MO-13-529	20 mm
MO-13-530	25 mm

20.5 cm / 8"
Gouges

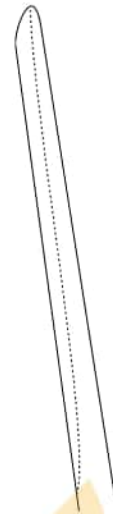

Stille

MO-13-531	10 mm
MO-13-532	12 mm
MO-13-533	15 mm
MO-13-534	20 mm
MO-13-535	25 mm

20.5 cm / 8"
Gouges
For taking grafts from the ribs



Stille

MO-13-2633	8 mm
MO-13-2634	10 mm
MO-13-2635	12 mm
MO-13-2636	15 mm
MO-13-2637	20 mm
MO-13-2638	25 mm

20.5 cm / 8"
Osteotomes



Stille

MO-13-539	10 mm
MO-13-540	12 mm
MO-13-541	15 mm
MO-13-542	20 mm
MO-13-543	25 mm

20.5 cm / 8"
Osteotomes, straight



Stille

MO-13-544	10 mm
MO-13-545	12 mm
MO-13-546	15 mm
MO-13-547	20 mm
MO-13-548	25 mm

20.5 cm / 8"
Osteotomes, curved

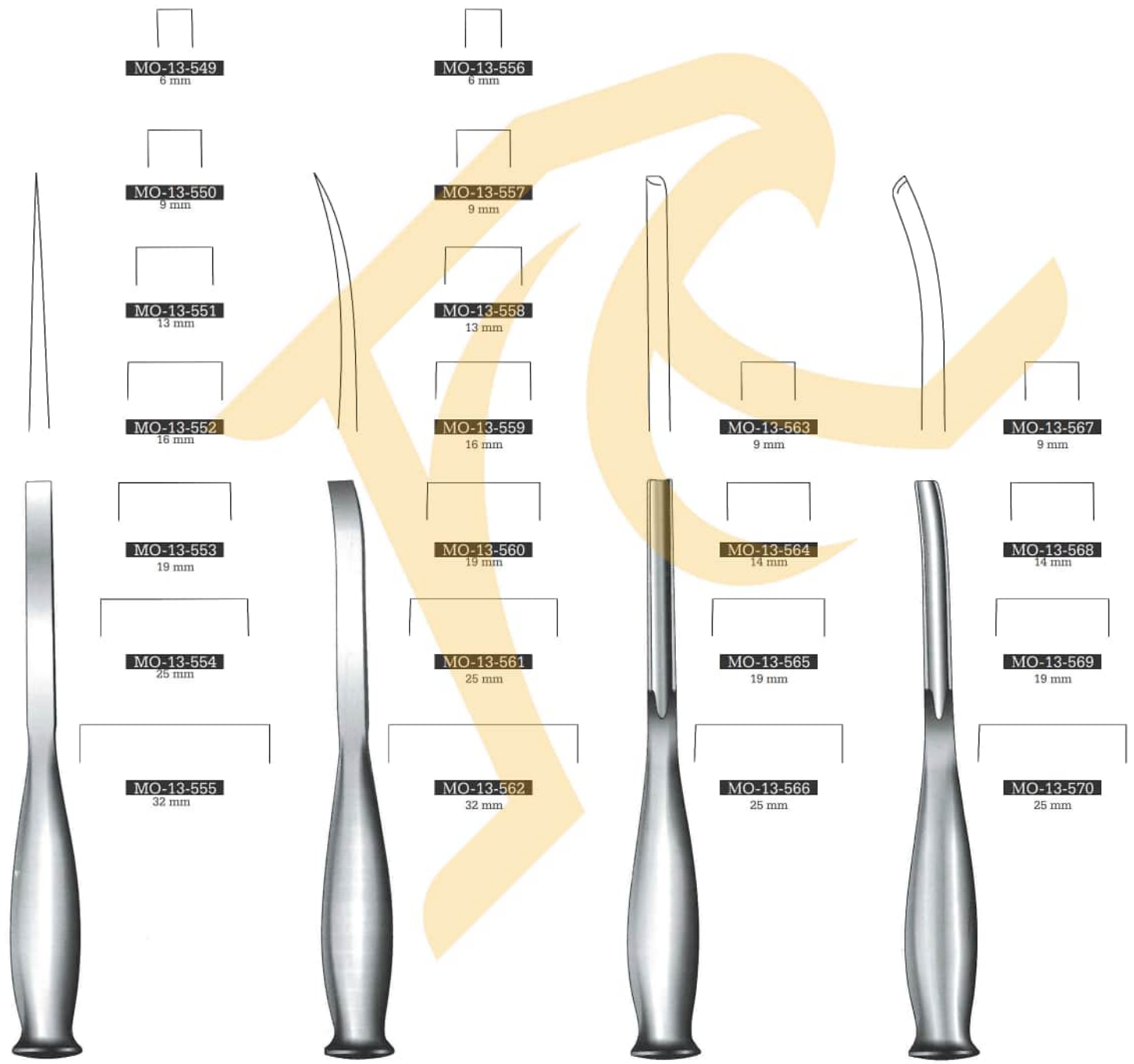

Smith Peterson
 20 cm / 8"

Smith Peterson
 20 cm / 8"

Smith Peterson
 20 cm / 8"

Smith Peterson
 20 cm / 8"

The image displays two main types of surgical instruments: Hibbs / Hilder Chisels and Hibbs / Hilder Osteotomes. Each instrument is shown in a detailed perspective view and a corresponding technical drawing. The technical drawings specify the instrument's length in centimeters and inches, and the width of the blade in millimeters. A large, stylized orange graphic is overlaid on the central part of the page.

Instrument Type	Model Number	Length (cm / in)	Blade Width (mm)
Hibbs / Hilder Chisel	MO-13-571	24 cm / 9½"	6 mm
	MO-13-3111	18 cm / 7"	6 mm
	MO-13-572	24 cm / 9½"	13 mm
	MO-13-3112	18 cm / 7"	13 mm
	MO-13-573	24 cm / 9½"	19 mm
	MO-13-3113	18 cm / 7"	19 mm
	MO-13-574	24 cm / 9½"	25 mm
	MO-13-3114	18 cm / 7"	25 mm
	MO-13-575	24 cm / 9½"	32 mm
	MO-13-576	24 cm / 9½"	32 mm
Hibbs / Hilder Osteotome	MO-13-2640	24 cm / 9½"	6 mm
	MO-13-577	24 cm / 9½"	10 mm
	MO-13-2641	24 cm / 9½"	13 mm
	MO-13-578	24 cm / 9½"	16 mm
	MO-13-579	24 cm / 9½"	19 mm
	MO-13-580	24 cm / 9½"	25 mm
	MO-13-581	24 cm / 9½"	32 mm
	MO-13-3121	18 cm / 7"	6 mm
	MO-13-3122	18 cm / 7"	10 mm
	MO-13-3123	18 cm / 7"	13 mm
	MO-13-3124	18 cm / 7"	16 mm
	MO-13-3125	18 cm / 7"	19 mm
	MO-13-3126	18 cm / 7"	25 mm
	MO-13-3127	18 cm / 7"	32 mm
	MO-13-582	24 cm / 9½"	6 mm
	MO-13-583	24 cm / 9½"	10 mm
	MO-13-584	24 cm / 9½"	13 mm
MO-13-585	24 cm / 9½"	16 mm	
MO-13-3131	18 cm / 7"	6 mm	
MO-13-3132	18 cm / 7"	10 mm	
MO-13-3133	18 cm / 7"	13 mm	
MO-13-3134	18 cm / 7"	16 mm	
MO-13-3135	18 cm / 7"	19 mm	
MO-13-3136	18 cm / 7"	25 mm	
MO-13-3137	18 cm / 7"	32 mm	

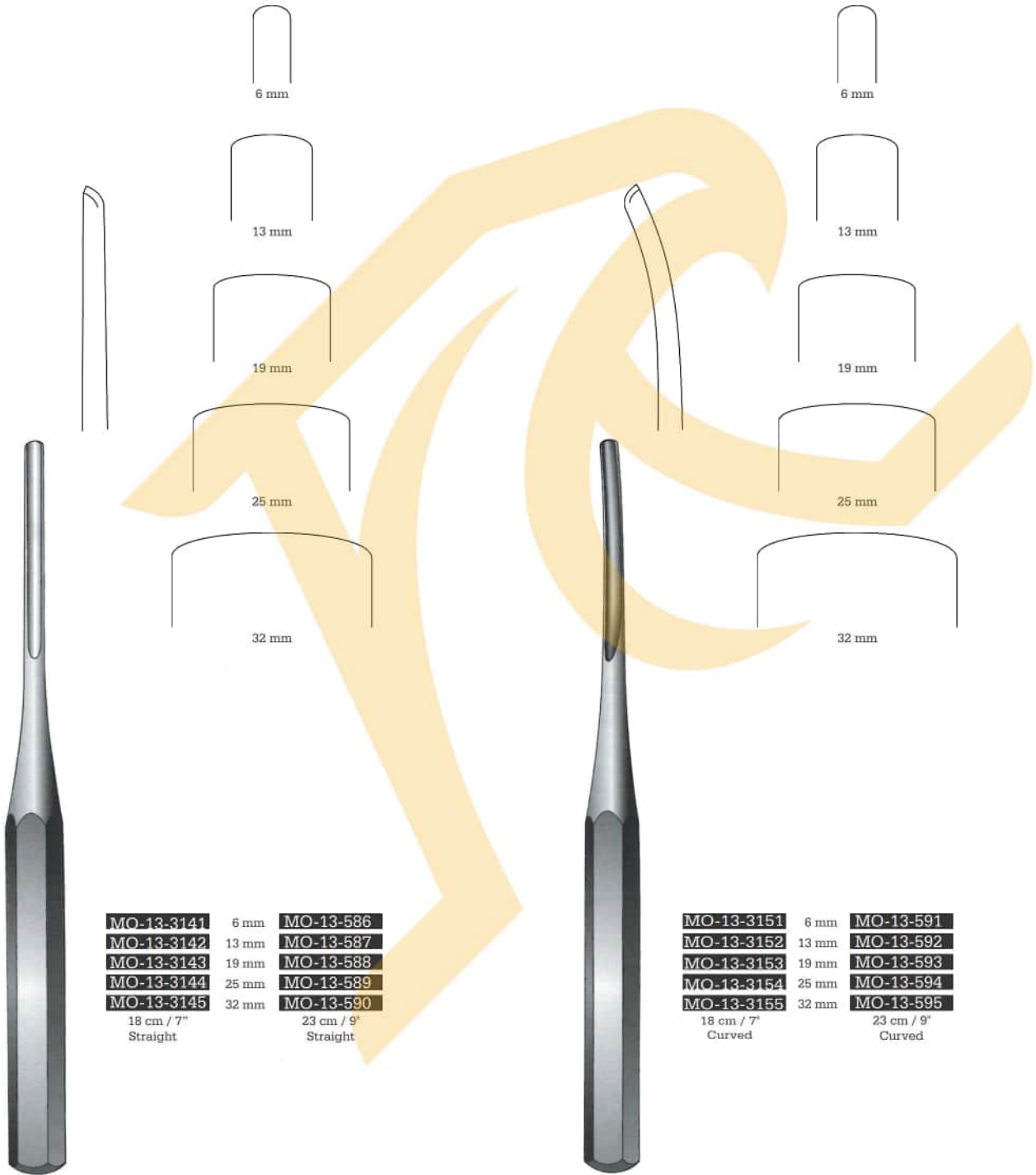

- | | | |
|-------------------|-------|------------------|
| MO-13-3141 | 6 mm | MO-13-586 |
| MO-13-3142 | 13 mm | MO-13-587 |
| MO-13-3143 | 19 mm | MO-13-588 |
| MO-13-3144 | 25 mm | MO-13-589 |
| MO-13-3145 | 32 mm | MO-13-590 |
| 18 cm / 7" | | 23 cm / 9" |
| Straight | | Straight |

- | | | |
|-------------------|-------|------------------|
| MO-13-3151 | 6 mm | MO-13-591 |
| MO-13-3152 | 13 mm | MO-13-592 |
| MO-13-3153 | 19 mm | MO-13-593 |
| MO-13-3154 | 25 mm | MO-13-594 |
| MO-13-3155 | 32 mm | MO-13-595 |
| 18 cm / 7" | | 23 cm / 9" |
| Curved | | Curved |

Hilder
Gouge

Hilder
Gouge



Farabeuf
21 cm / 8 1/4"
Osteotome

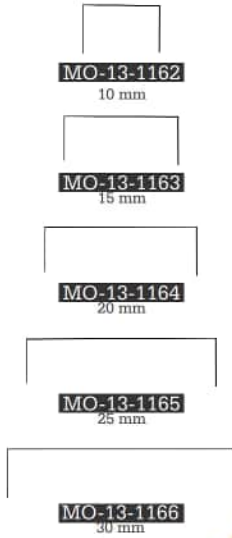

Farabeuf
25 cm / 10"
Chisel



Hautant
13 cm / 5"
Chisel

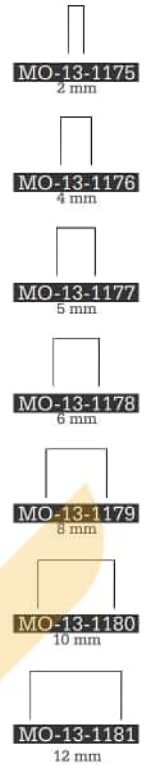

Judet
22 cm / 8 3/4"
Chisel

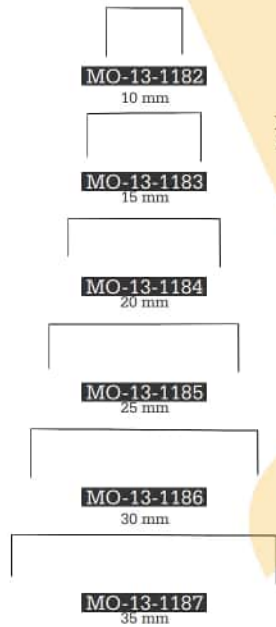

Letourne
35 cm / 14"
Gouge

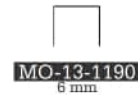



Laucas Championniere
21 cm / 8¼"



Maceven
20 cm / 8"

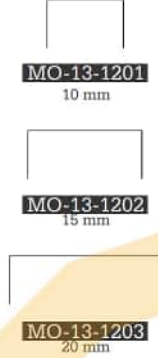

Mante
13 cm / 5"



Ombredanne
14 cm / 5½"

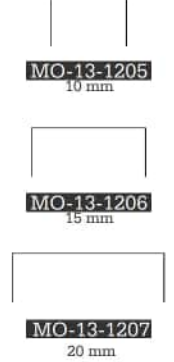

Partsch

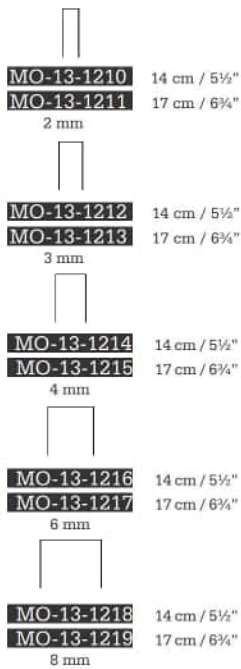

Poirier
16 cm / 6¼"

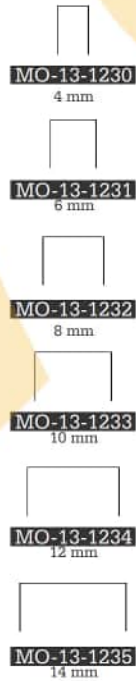

Portmann
16 cm / 6¼"

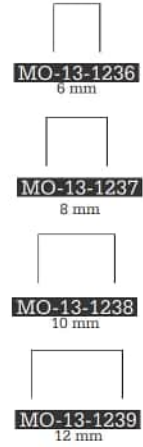

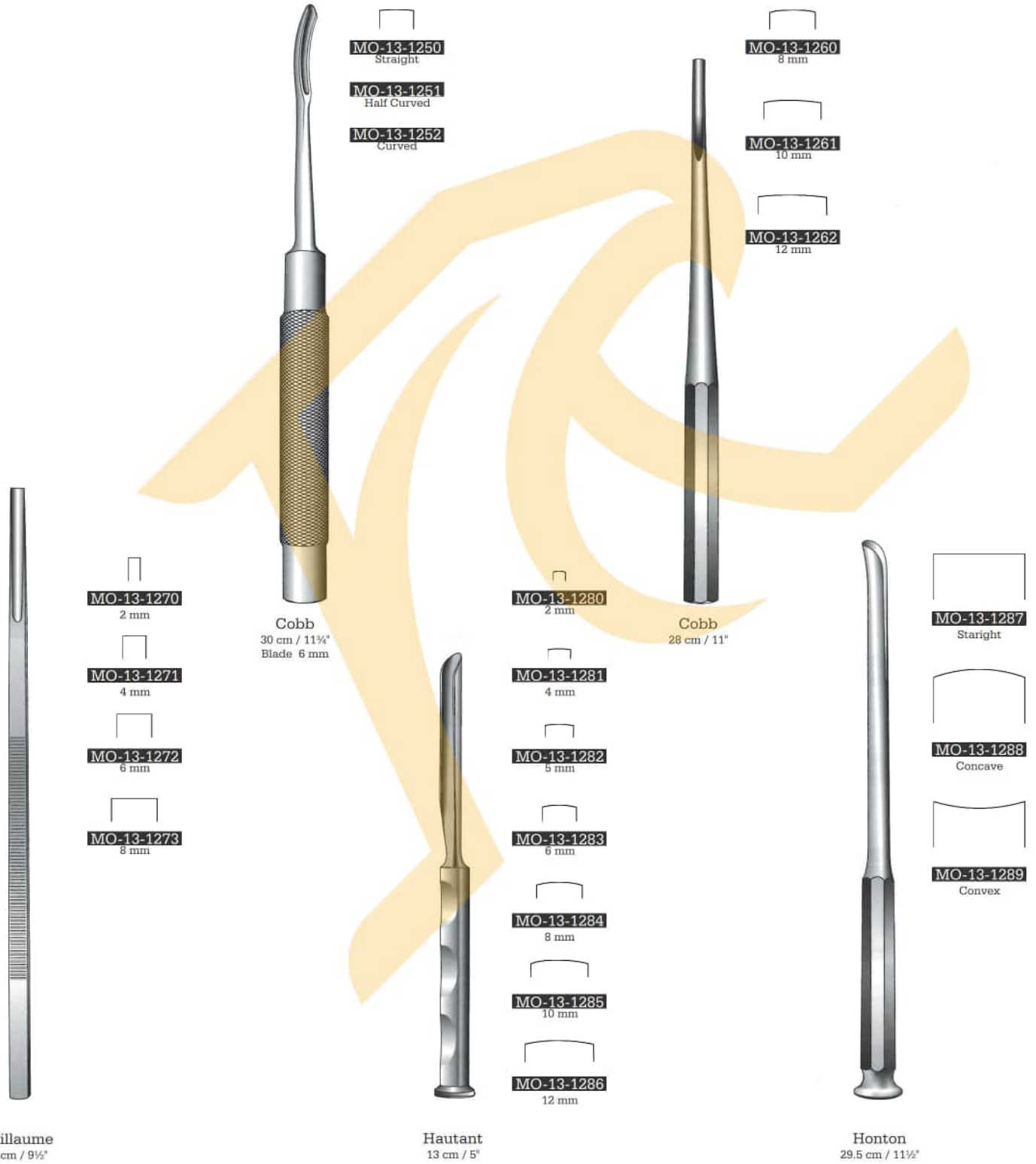

Orthopedic

Gougets
HohlmeiBel
Gubias



Poirier-Trillat
20 cm / 8"

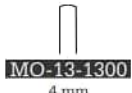

MO-13-1300
4 mm



MO-13-1301
6 mm



MO-13-1302
8 mm



MO-13-1303
10 mm



MO-13-1304
12 mm



MO-13-1305
14 mm



Poirier
16 cm / 6 1/4"



MO-13-1290
2 mm



MO-13-1291
4 mm



MO-13-1292
6 mm



MO-13-1293
8 mm



MO-13-1294
10 mm



MO-13-1295
12 mm



MO-13-1296
14 mm



Postel
25 cm / 10"



MO-13-1310 Straight

MO-13-1311 Angled 135°

MO-13-1312 Angled 150°

8 mm



MO-13-1320

30 mm



Putti
25 cm / 10"

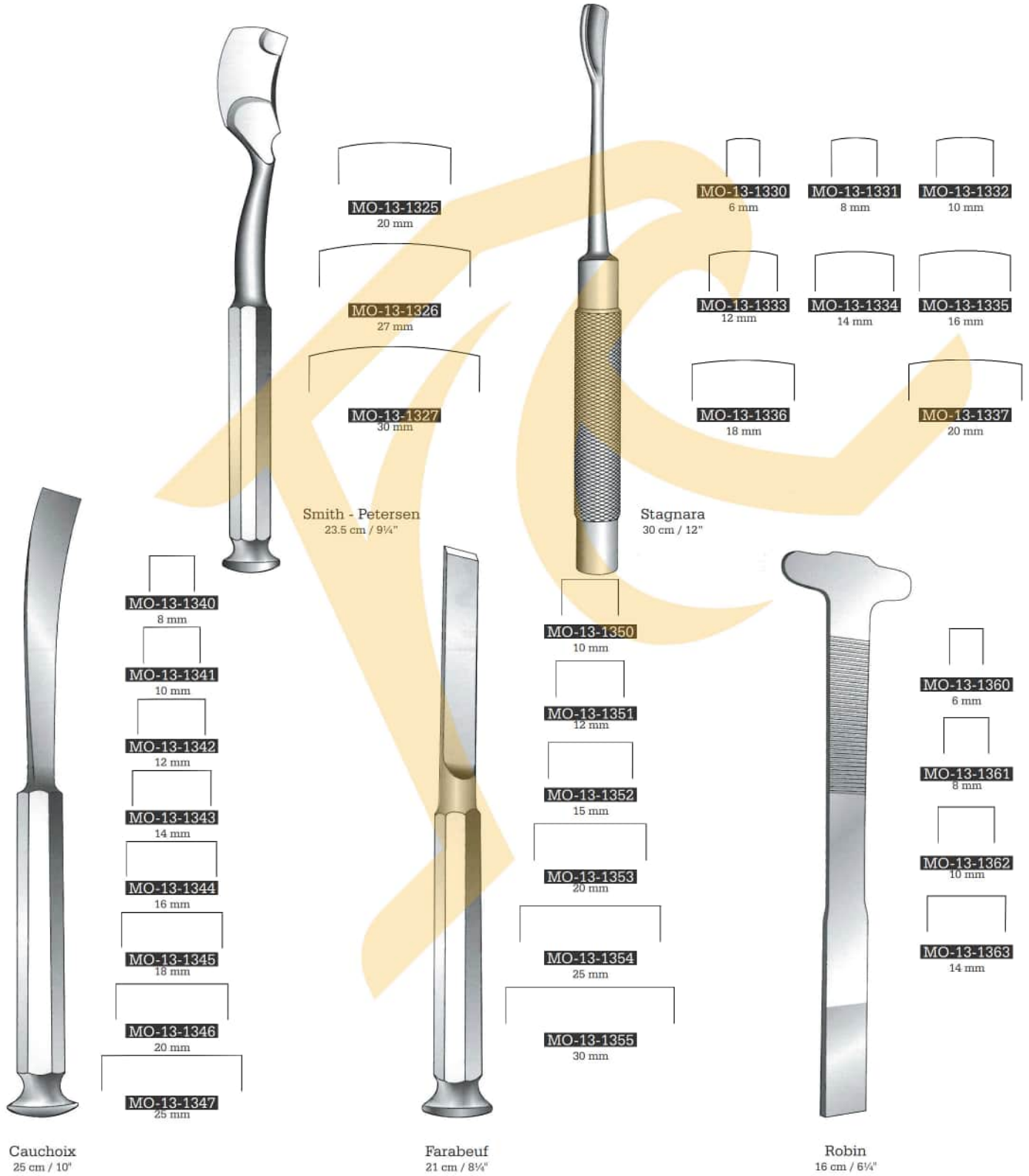

Orthopedic

Bone Chisels And Gouges

Meibei Und Osteotme

Cinceles Y Gubias Para Huesos



Lebsche
MO-13-120
24.5 cm / 9 3/4"



Virchow
MO-13-1620
Skull breaker



MO-13-1625
22 cm / 8 3/4"



Brunetti
MO-13-1630
28 cm / 11"
Left



Brunetti
MO-13-1635
28 cm / 11"
Right



Cobb
MO-13-601 Tip 10 mm
MO-13-602 Tip 13 mm
MO-13-603 Tip 19 mm
29 cm / 11 1/2"
Spinal elevator



MO-13-605
Straight



MO-13-606
Medium curve



MO-13-607
Strong curve



MO-13-608
Reverse curve



Cobb
28 cm / 11"
Spinal gouge
7 mm blade width



Mini-Lexer
18 cm / 7"
Ferrozell handle

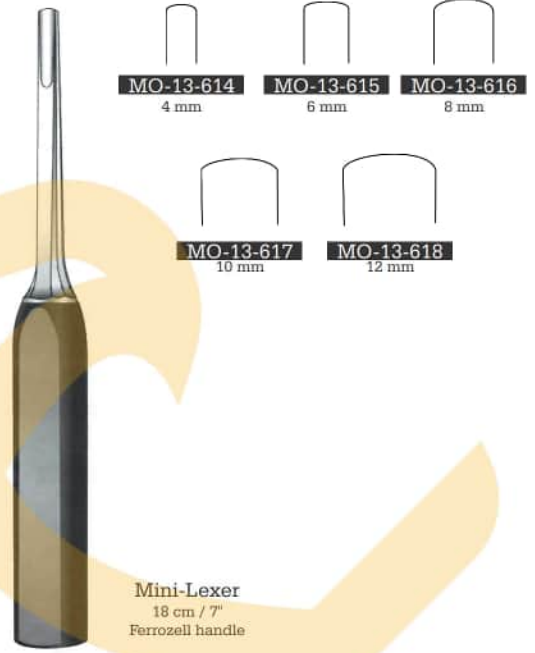
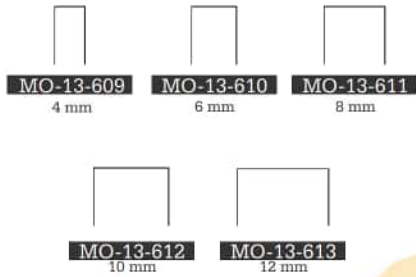

Mini-Lexer
18 cm / 7"
Ferrozell handle

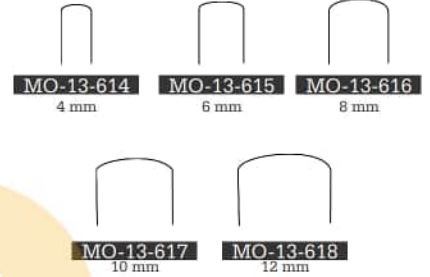

Lexer
22 cm / 8 3/4"
Ferrozell handle

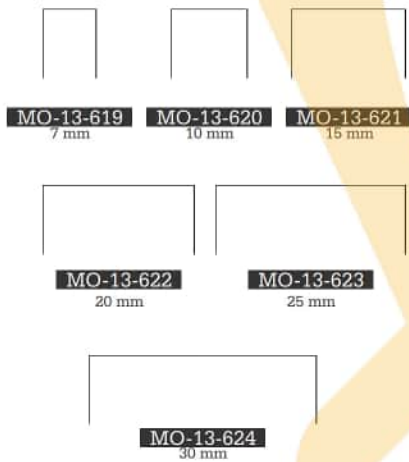

Lexer
22 cm / 8 3/4"
Ferrozell handle

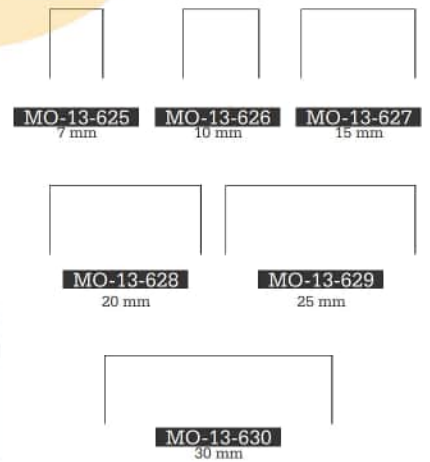

Orthopedic

Wedge Osteotomes, Blade Osteotomes

Keilosteotome, Blattosteotome

Osteotomos de Cuna, Osteotomos de Hojas

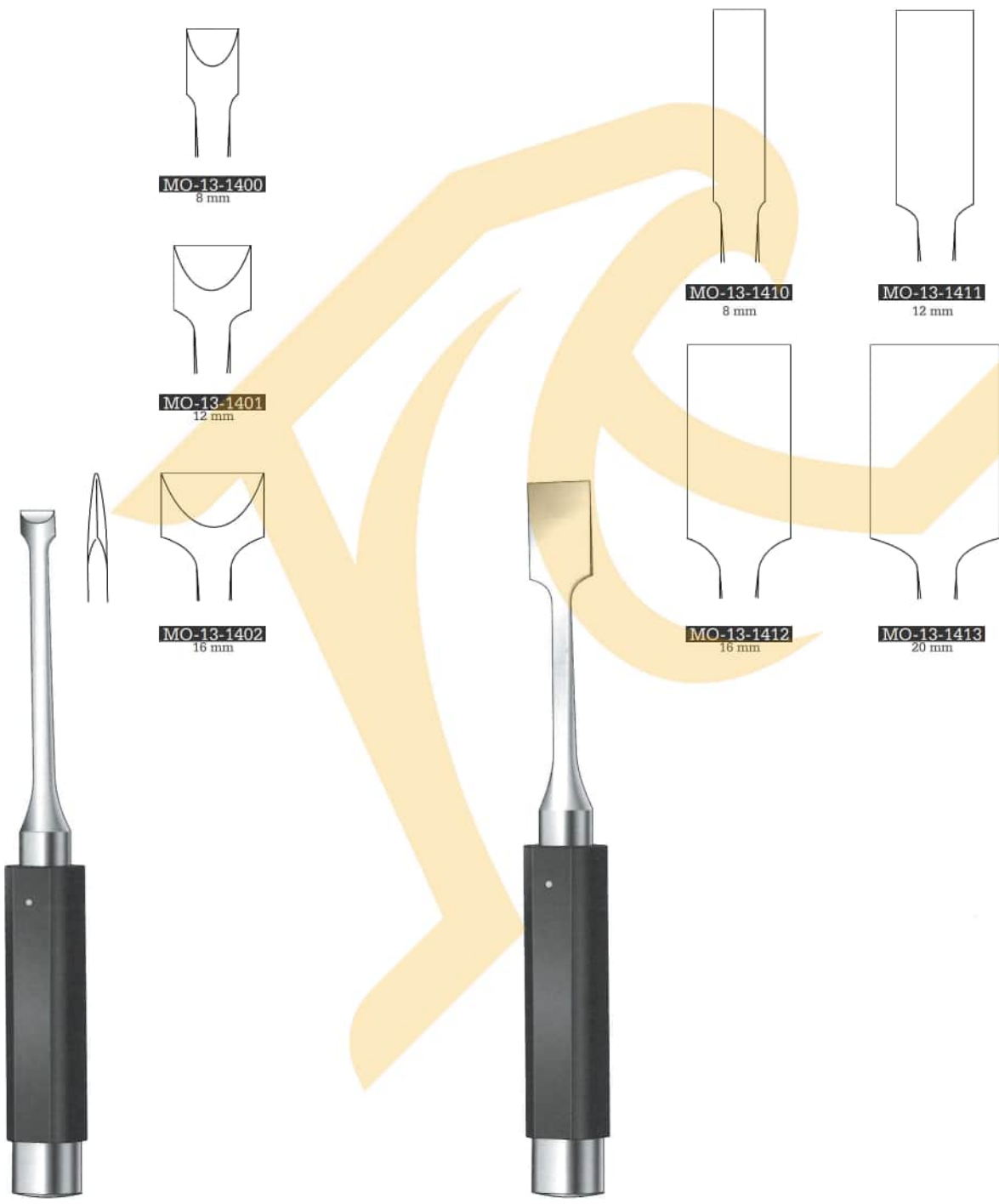

Obwegeser

Obwegeser

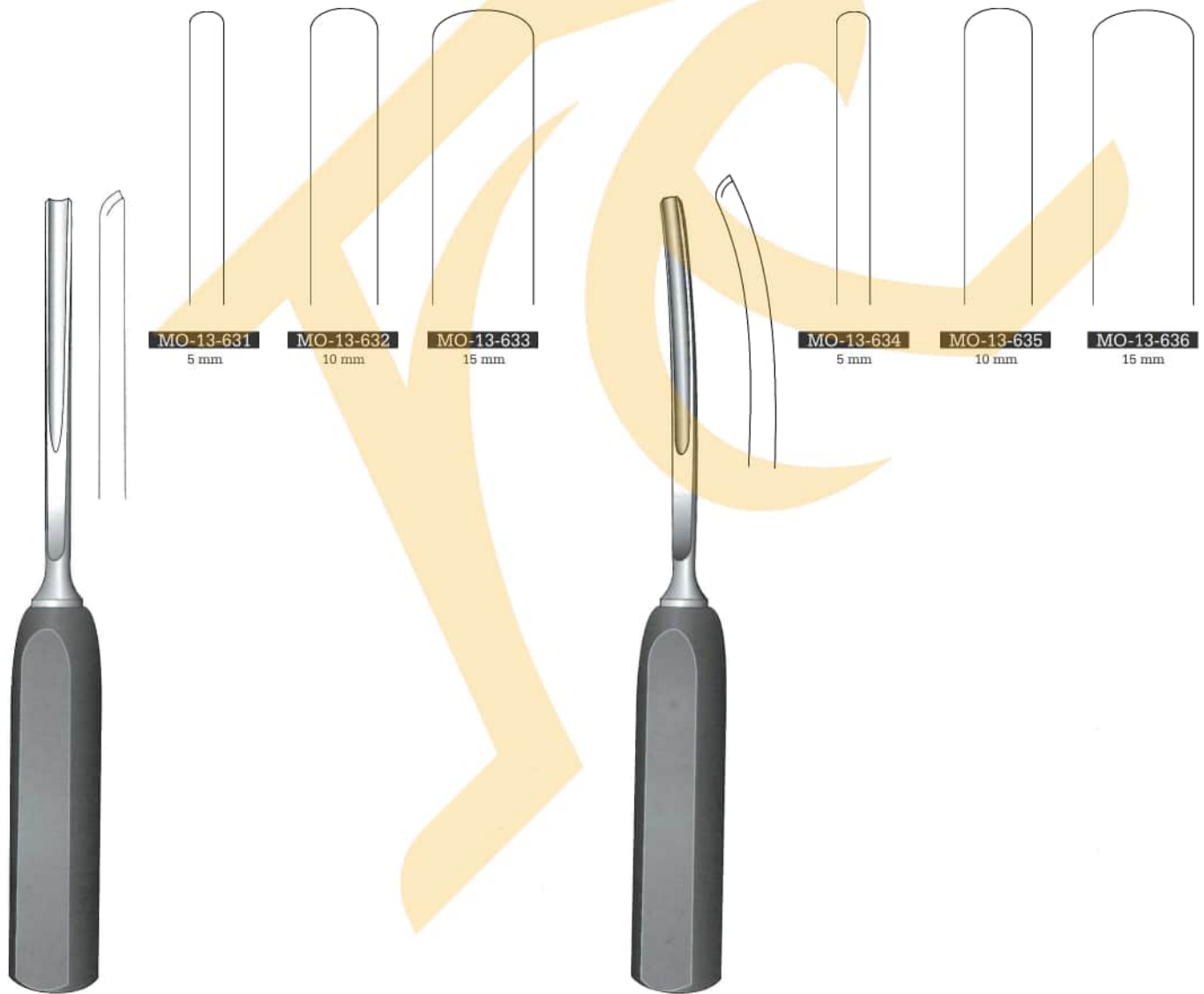

Lexer
25 cm / 10"
Ferozell handle

Lexer
25 cm / 10"
Ferozell handle

Orthopedic

Bone Osteotome Chisels And Gouges

Meibei Und Osteotome

Cinceles Y Gubias Paja Huesos



MO-13-637
24.5 cm / 9 3/4"
20 mm
Ferrozell handle

MO-13-638
26.5 cm / 10 1/2"
16 mm
Ferrozell handle, curved

Lexer
MO-13-639 10 mm
MO-13-2039 15 mm
27.5 cm / 10 3/4"
Ferrozell handle

Lexer
MO-13-640 10 mm
MO-13-2040 15 mm
27.5 cm / 10 3/4"
Ferrozell handle

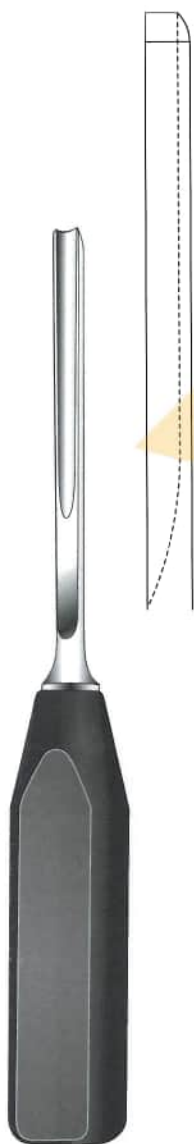

MO-13-641 5 mm
MO-13-642 10 mm
MO-13-643 15 mm
25 cm / 10"
Ferrozell handle
Spongiosa gouge



Lamina
MO-13-644 6 mm
MO-13-645 8 mm
MO-13-646 11 mm
MO-13-647 16 mm
23.5 cm / 9 1/4"
Ferrozell handle



MO-13-648 5 mm
MO-13-649 10 mm
MO-13-650 15 mm
mm
25 cm / 10"
Curved
Ferrozell handle
Spongiosa gouge

Orthopedic

Gouges
Hohlmeißel
Gubias

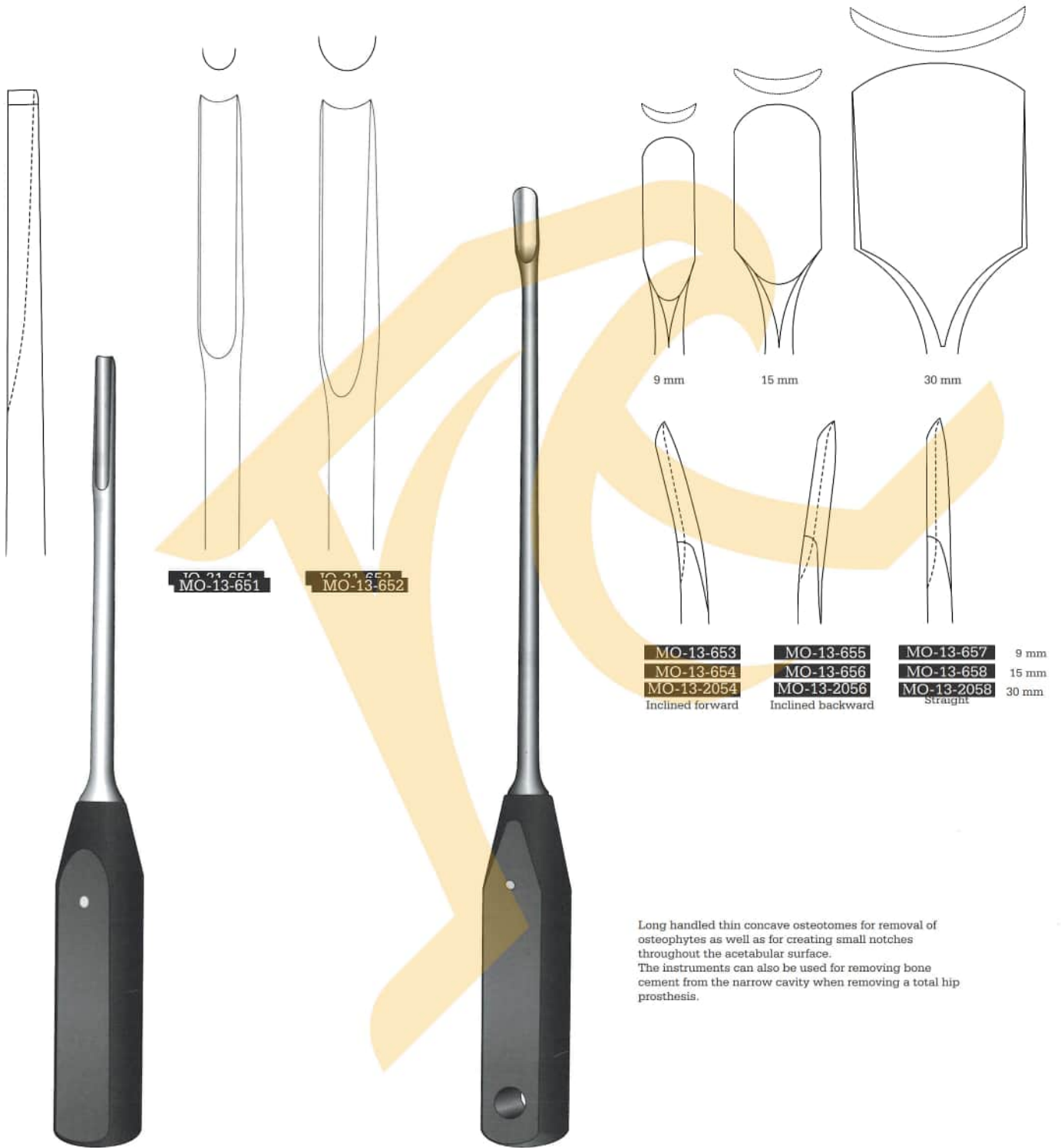

MO-13-651
MO-13-651

MO-13-652
MO-13-652

MO-13-653

MO-13-654

MO-13-2054

Inclined forward

MO-13-655

MO-13-656

MO-13-2056

Inclined backward

MO-13-657

MO-13-658

MO-13-2058

Straight

9 mm

15 mm

30 mm

Lexer
28 cm / 11"
Ferrozell handle
Spongiosa gouge

Wagner
34 cm / 13½"
Ferrozell handle

Long handled thin concave osteotomes for removal of osteophytes as well as for creating small notches throughout the acetabular surface. The instruments can also be used for removing bone cement from the narrow cavity when removing a total hip prosthesis.



MO-13-2100
18.5 cm / 7 1/4"
Handle, only
Ferrozell handle

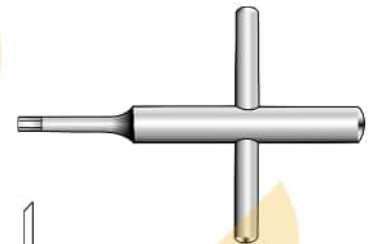
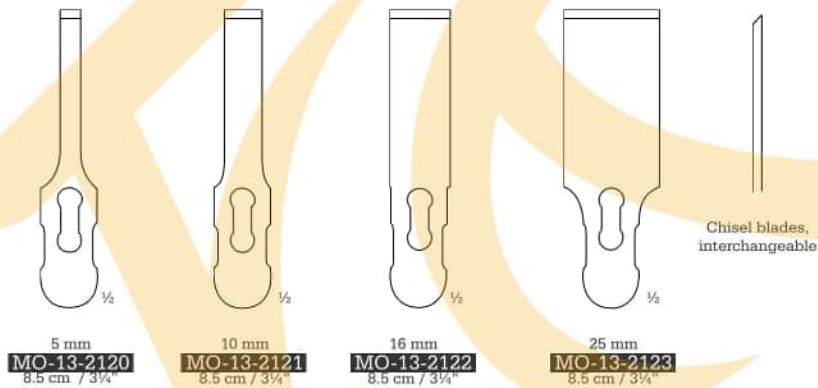
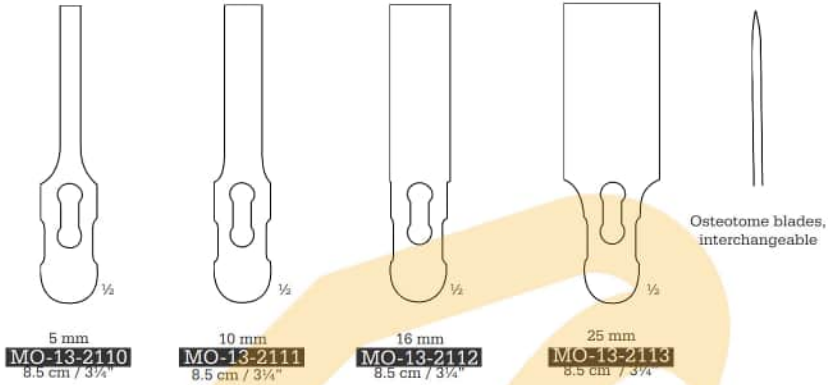

Gouge blades, interchangeable

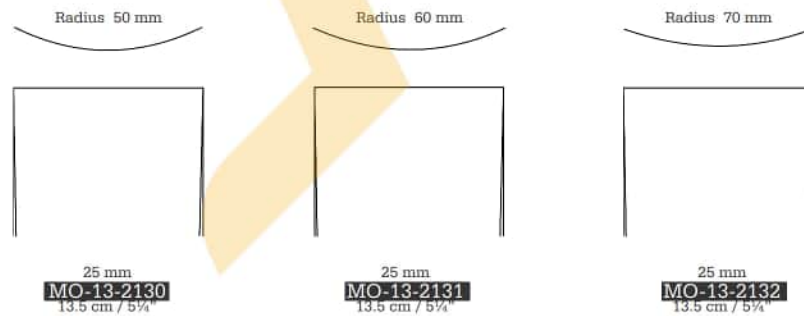

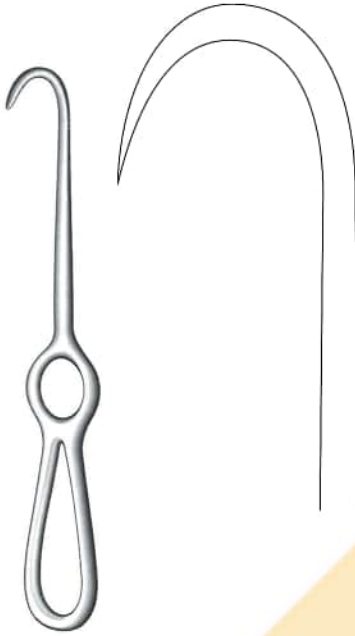

Volkmann
MO-13-659
 20 cm / 8"
 19 x 27 mm
 Sharp

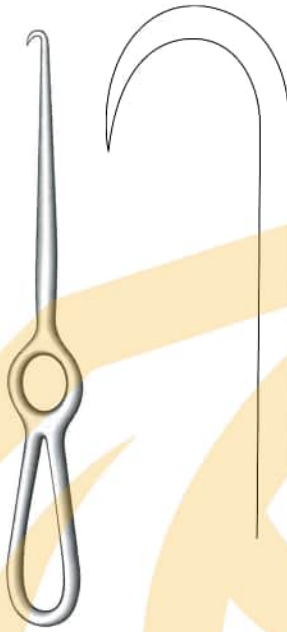

Volkmann
MO-13-660
 23 cm / 9"
 15 x 20 mm
 Sharp

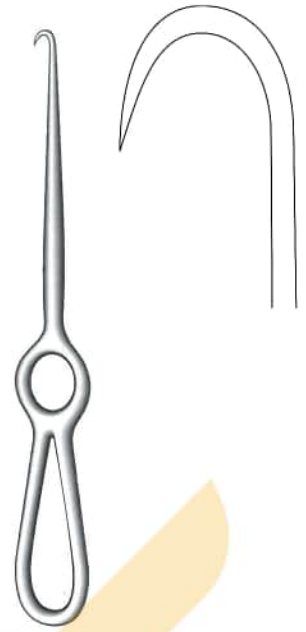

Volkmann
MO-13-661
 25 cm / 9 3/4"
 15 x 20 mm
 Sharp



23 cm / 9"
 Sharp
 Bone hook with grip handle



MO-13-664
 6 x 10 mm
 Small

MO-13-665
 11 x 18 mm
 Medium

MO-13-666
 12 x 30 mm
 Large



MO-13-667 18
 cm / 7"
 18 x 21 mm
 Sharp with T-handle
 large, for femurs



Zygoma
MO-13-1655
 17 cm / 6 3/4"

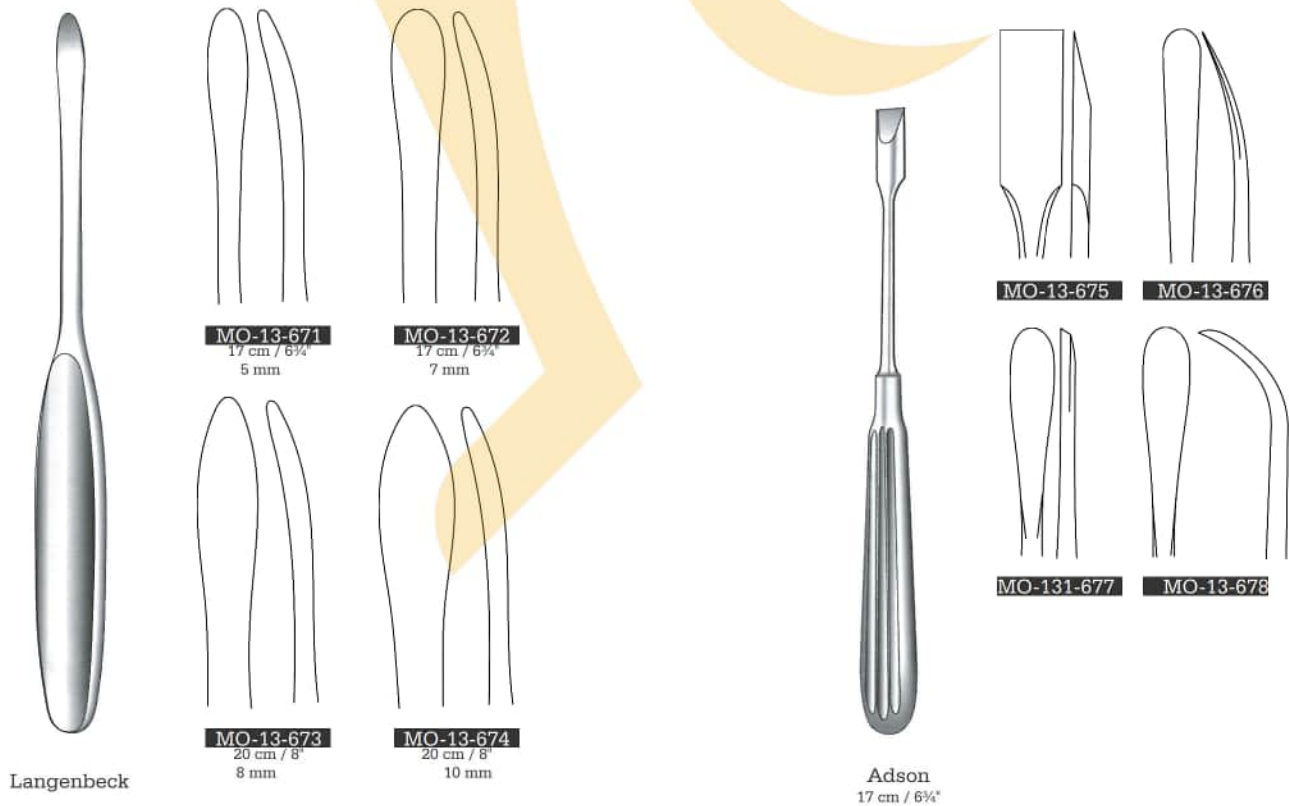
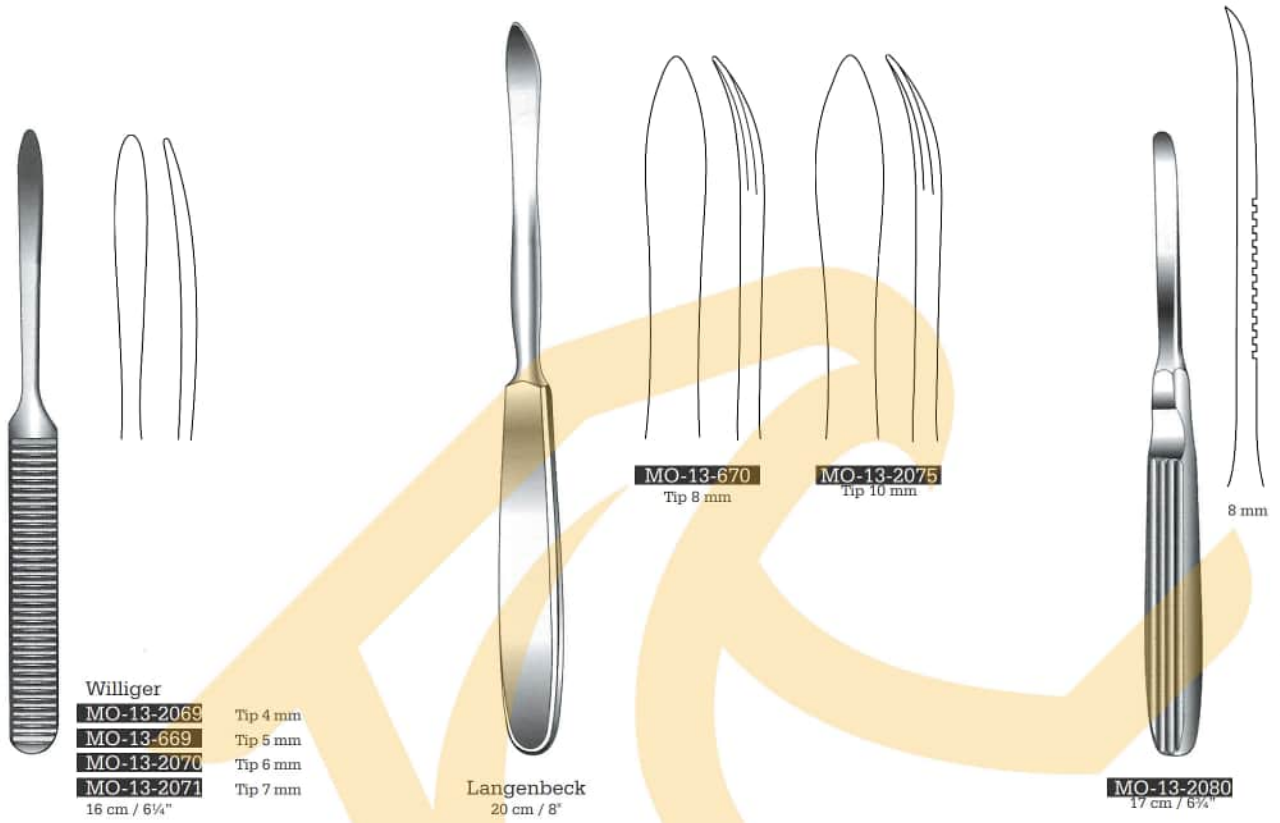



Matson
MO-13-679
22 cm / 8 3/4"

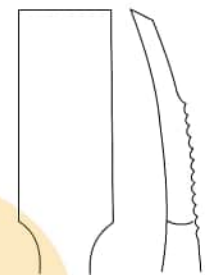

Alexander
MO-13-680
20 cm / 8"



MO-13-681
17.5 cm / 7"



MO-13-682
21 cm / 8 1/4"



MO-13-683
17.5 cm / 7"



MO-13-684
21 cm / 8 1/4"



MO-13-685
20.5 cm / 8"

Semb

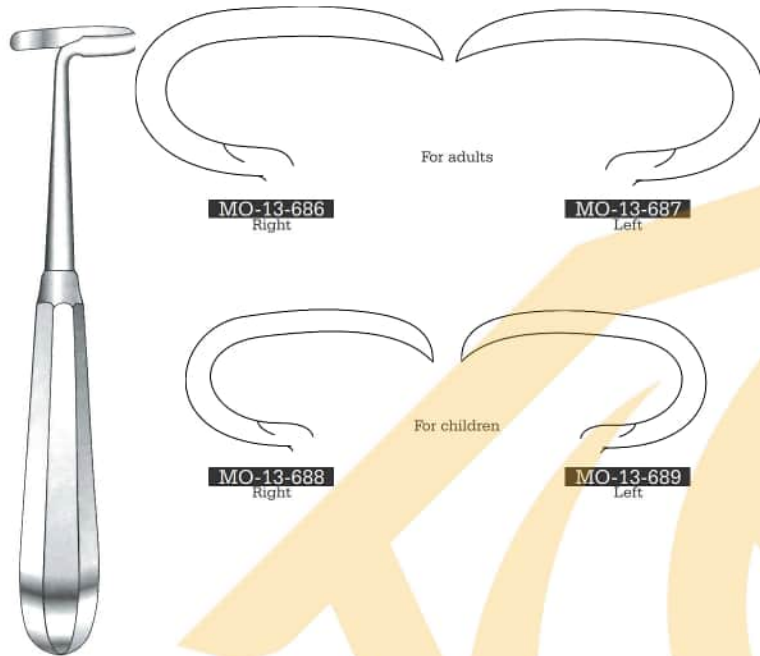

Doyen
17 cm / 6 3/4"

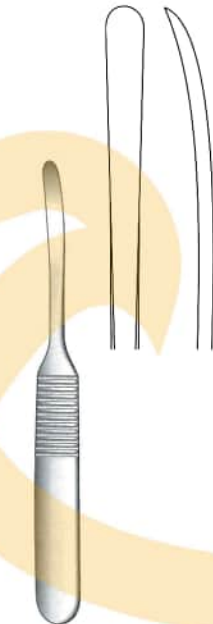

Williger
MO-13-690
13 cm / 5"
5 mm



Williger
MO-13-691 4 mm
MO-13-1991 5 mm
MO-13-1992 6 mm
MO-13-1993 7 mm
16 cm / 6 1/4"

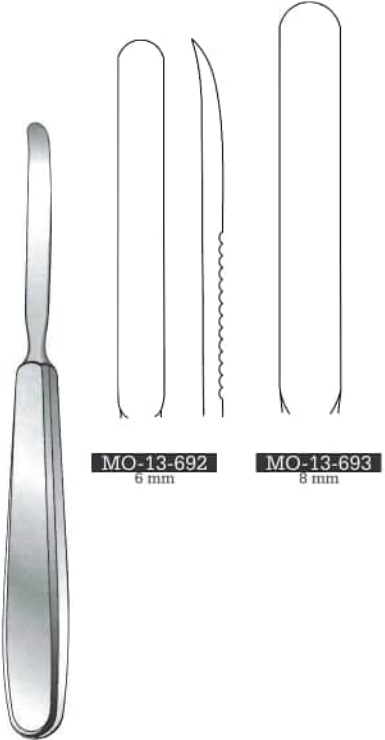

MO-13-692 6 mm
MO-13-693 8 mm

17 cm / 6 3/4"



Lambotte
21 cm / 8 1/4"

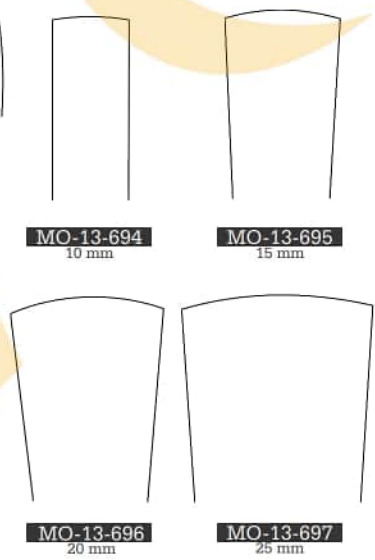

MO-13-694 10 mm
MO-13-695 15 mm
MO-13-696 20 mm
MO-13-697 25 mm

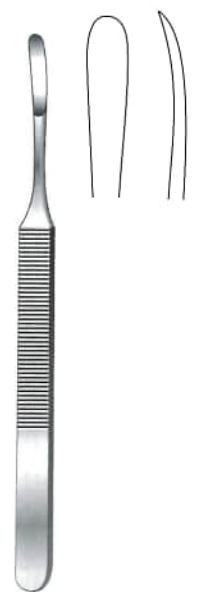

Konig
MO-13-1990
15.5 cm / 6"

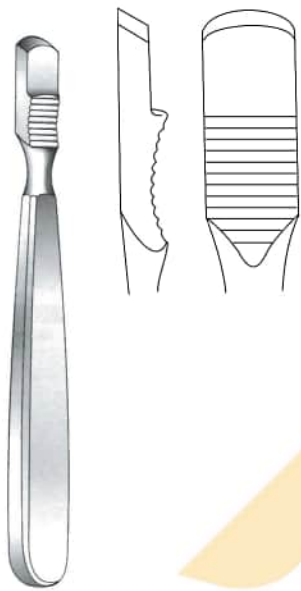

Farabeuf
MO-13-698
15 cm / 6"
Straight



Farabeuf
MO-13-699
15 cm / 6"
Curved

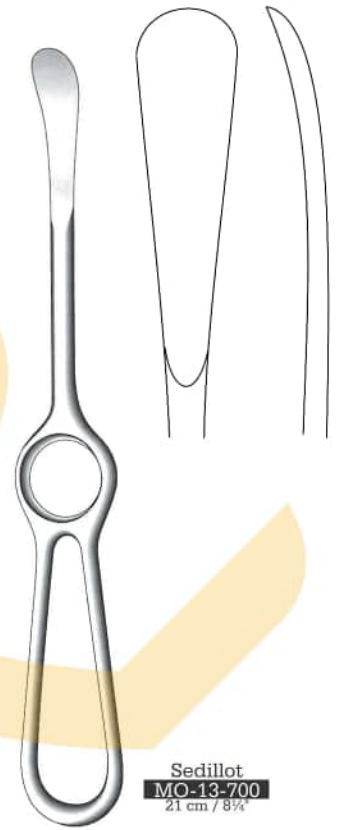

Sedillot
MO-13-700
21 cm / 8 1/4"



16 cm / 6 1/4"
Delicate, Solid

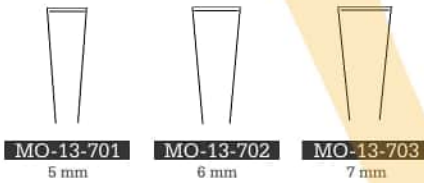

MO-13-701
5 mm

MO-13-702
6 mm

MO-13-703
7 mm



Langenbeck
MO-13-704
18 cm / 7"

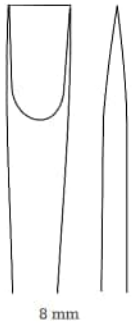

8 mm

Cushing
MO-13-705
 17 cm / 6 3/4"



Cushing

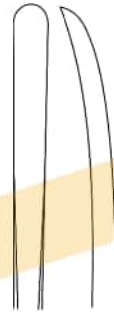

MO-13-706
 17 cm / 6 3/4"
 4 mm

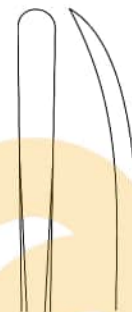

MO-13-707
 17 cm / 6 3/4"
 6 mm



MO-13-708
 19.5 cm / 7 3/4"
 5 mm

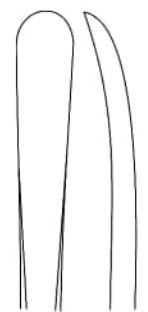

MO-13-709
 19.5 cm / 7 3/4"
 7 mm



MO-13-710
 19 cm / 7 1/2"
 16 mm



MO-13-711
 19 cm / 7 1/2"
 16 mm

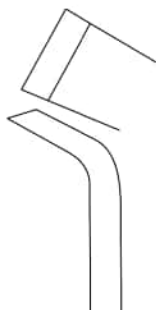

MO-13-712
 19 cm / 7 1/2"
 12 mm

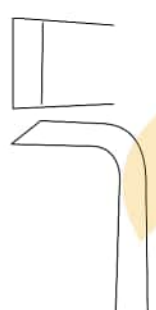

MO-13-713
 18 cm / 7"
 12 mm



Hoen



MO-13-714
 16 cm / 6 1/4"
 7 mm



MO-13-715
 18 cm / 7 1/4"
 15 mm



MO-13-716
 19 cm / 7 1/2"
 20 mm

Langenbeck



6 mm

MO-13-717
18 cm / 7"
Ferrozell handle

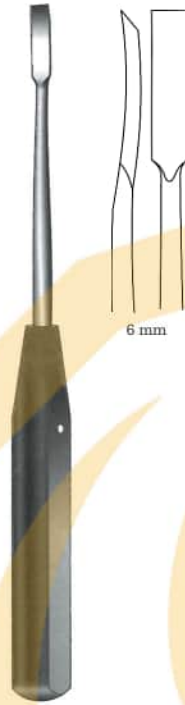

6 mm

MO-13-718
18 cm / 7"
Ferrozell handle



3 mm

MO-13-719
18 cm / 7"
Ferrozell handle



14 mm

MO-13-720
20 cm / 8"
Ferrozell handle

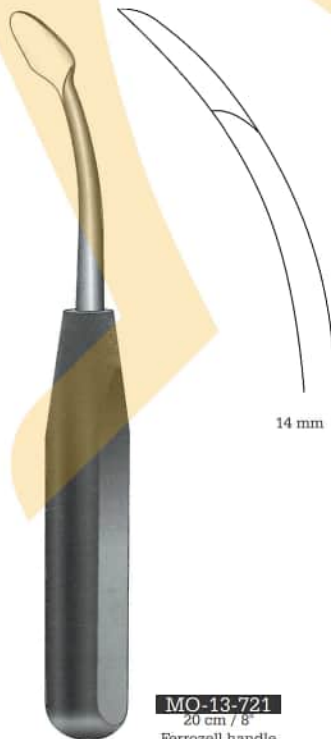

14 mm

MO-13-721
20 cm / 8"
Ferrozell handle



19 mm

MO-13-722
20 cm / 8"
Ferrozell handle

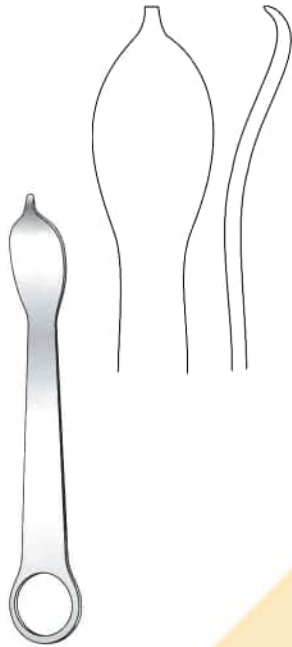

MO-13-723
16 mm

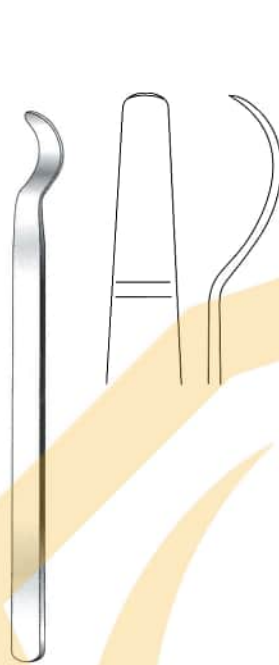

MO-13-724
14 cm / 5 1/2"



MO-13-2024
15 cm / 6"
5 mm

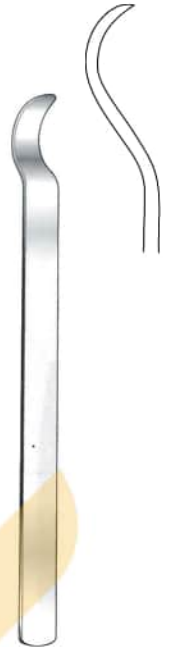

MO-13-2026
15 cm / 6"
7 mm

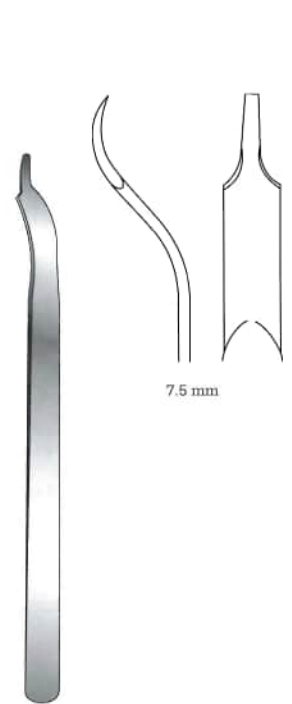

Buck-Gramcko
MO-13-2028
15 cm / 6"

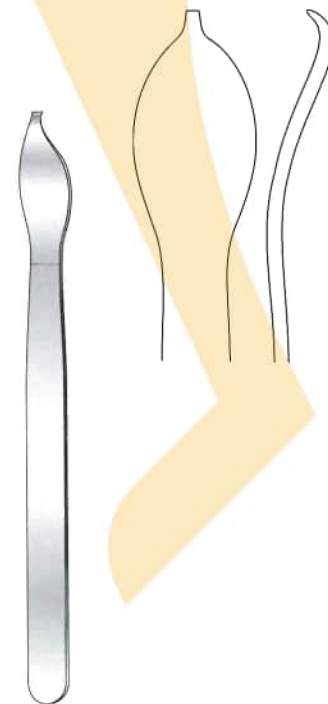

MO-13-725
15 mm



Hohmann-Mini
16 cm / 6 1/4"

MO-13-726
6 mm

MO-13-727
8 mm



Freer
MO-13-2160
18.5 cm / 7 1/4"
Sharp / Blunt

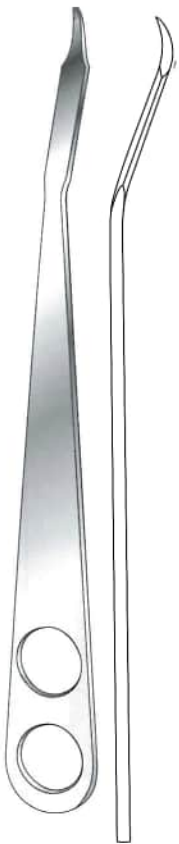

Hohmann
MO-13-728
8 mm
22 cm / 8¾"

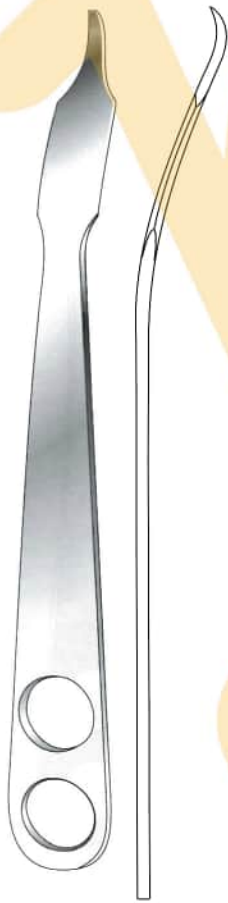

Hohmann
MO-13-729
18 mm
23.5 cm / 9¼"

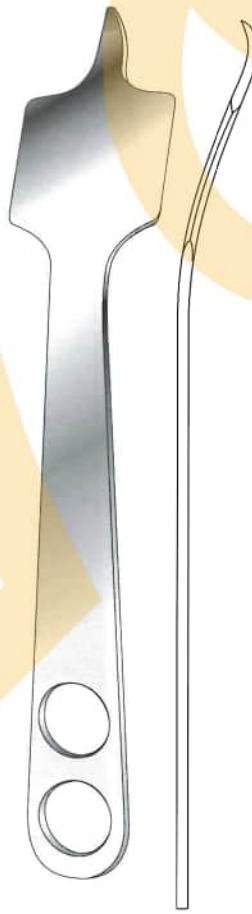

Hohmann
MO-13-730
43 mm
23.5 cm / 9¼"

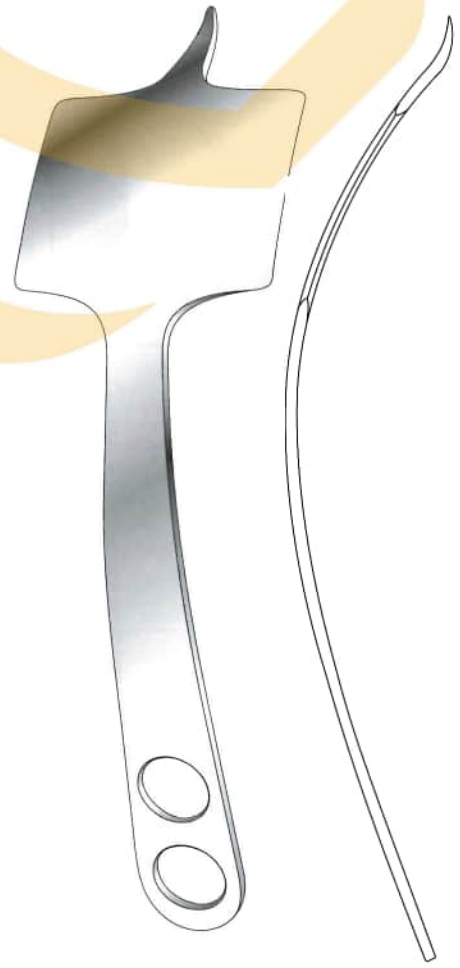

Hohmann
MO-13-731
70 mm
23.5 cm / 9¼"



Hohmann
MO-13-732
43 mm
23.5 cm / 9¹/₄"

Hohmann
MO-13-733
22 mm
25.5 cm / 10"

Hohmann
MO-13-734
33 mm
29 cm / 11"

Hohmann
MO-13-735
24 mm
27.5 cm / 10³/₄"

Lange-Hohmann
MO-13-736
22 mm
25 cm / 9³/₄"

Orthopedic

Bone Levers, Retractors

knochenhebel, Wundhaken

Elevadores para huesos, Separadores

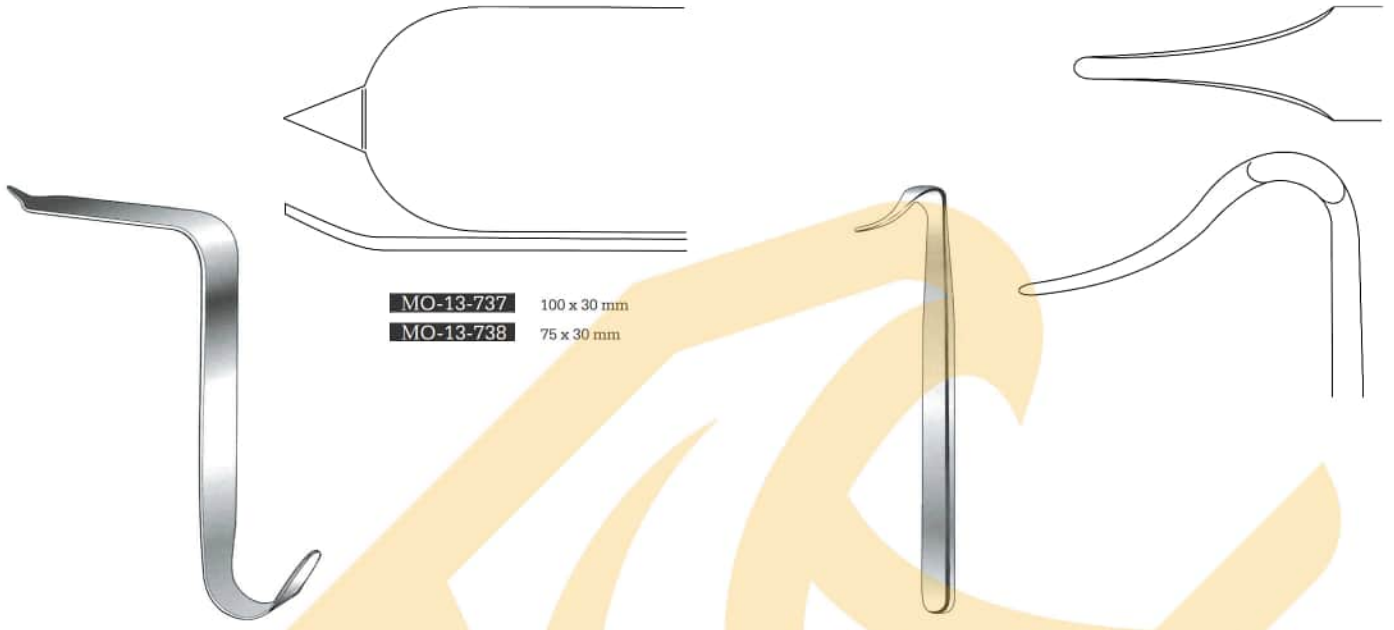

MO-13-737 100 x 30 mm
MO-13-738 75 x 30 mm

Taylor
16.5 cm / 6½"

Blount
MO-13-739
17.5 cm / 7"



Bennett
MO-13-740 Small
MO-13-2045 Large
24 cm / 9½"



Blount
MO-13-741
26 cm / 10¼"



Blount
MO-13-742
26 cm / 10¼"
Blunt



Smilie

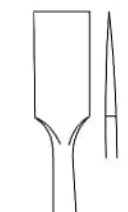

MO-13-743
17 cm / 6 3/4"

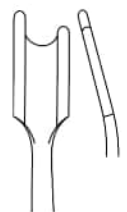

MO-13-744
Curved left

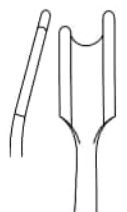

MO-13-745
Curved right



MO-13-746



MO-13-747



17 cm / 6 3/4"



Bircher
19 cm / 7 1/2"



MO-13-748



MO-13-749



Salenius
MO-13-750
22 cm / 8 3/4"



Salenius
MO-13-751
22 cm / 8 3/4"

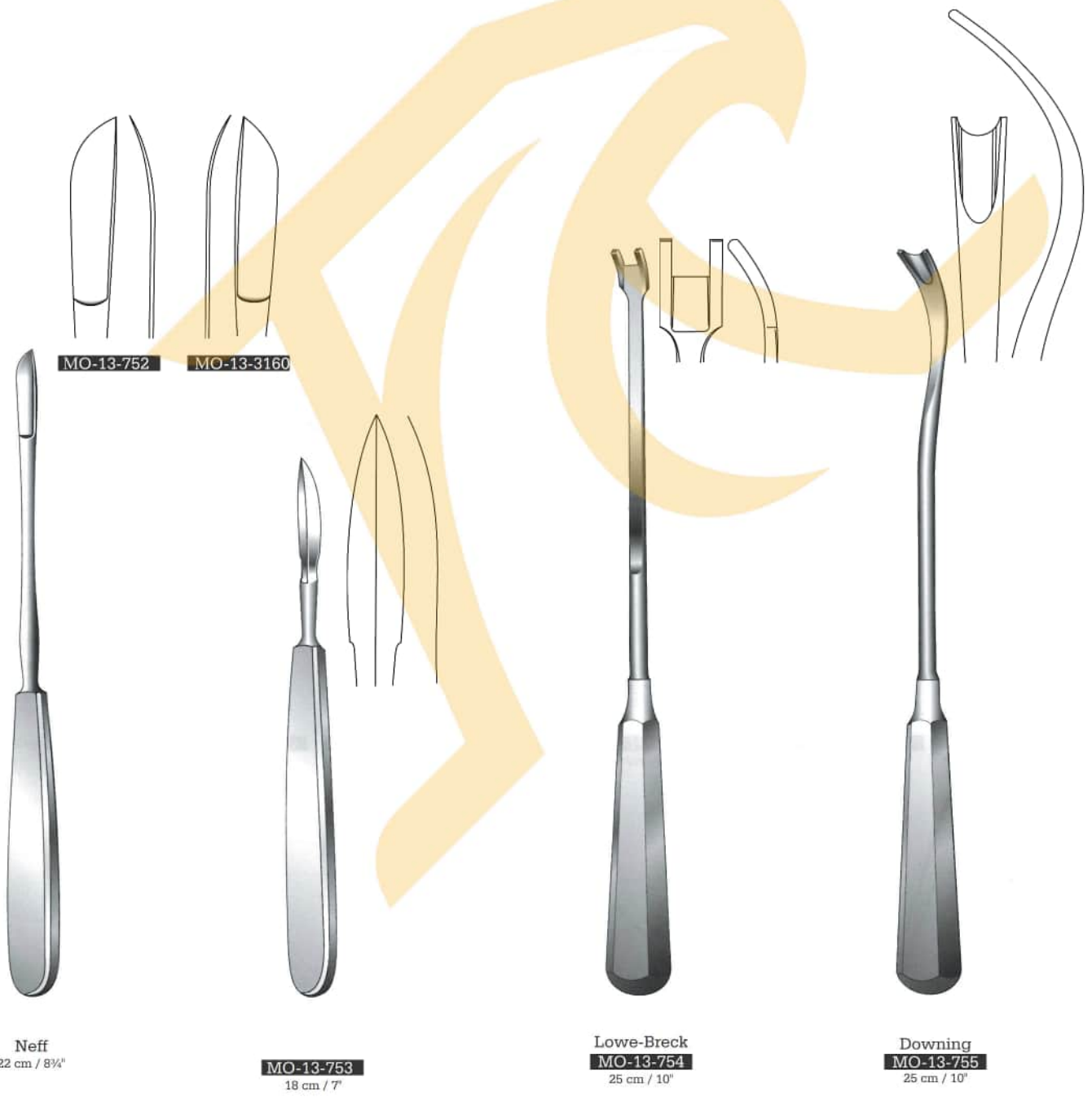

Neff
22 cm / 8 3/4"

MO-13-753
18 cm / 7"

Lowe-Breck
MO-13-754
25 cm / 10"

Downing
MO-13-755
25 cm / 10"

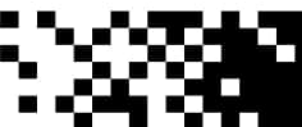

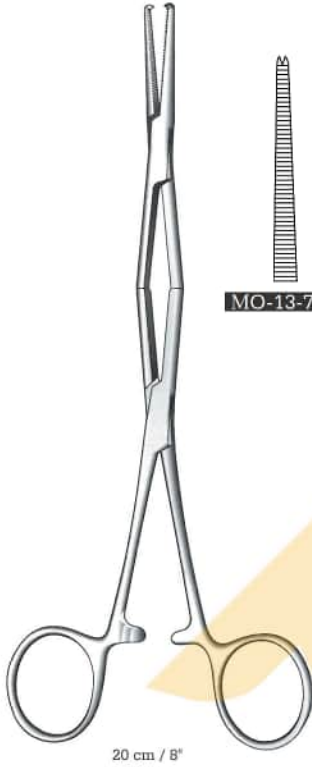

20 cm / 8"



MO-13-756



MO-13-757

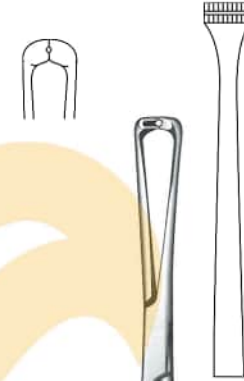

Steinmann
MO-13-758
16 cm / 6 1/4"



Brand



MO-13-759
15 cm / 6"



MO-13-760
19 cm / 7 1/2"



MO-13-761
24 cm / 9 1/2"



10 cm / 4"



MO-13-762
1.5 mm



MO-13-763
2.5 mm



MO-13-764
4.5 mm



MO-13-765
5.5 mm

Orthopedic

Bone Holding & Reduction Forceps

Knochenhaltezaugen

Pinzas para huesos

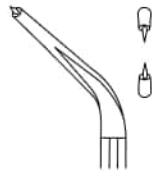

MO-13-766

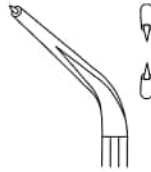

MO-13-767



9.5 cm / 3 3/4"
Reposition forceps
with stepped tips



MO-13-768
13.5 cm / 5 1/2"

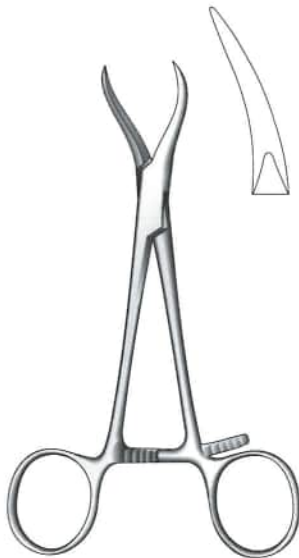

MO-13-769
13.5 cm / 5 1/4"
Reposition forceps,
especially for maxillary reposition

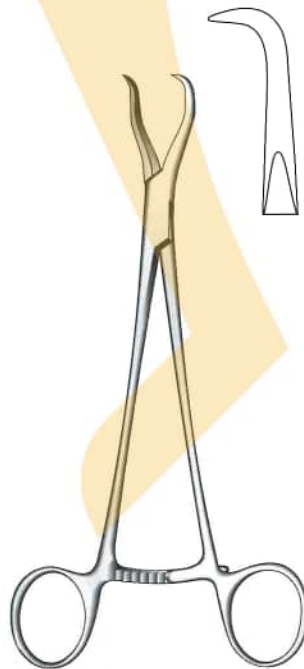

Haase
MO-13-770
16.5 cm / 6 1/2"
Reposition forceps
for mandibular fractures

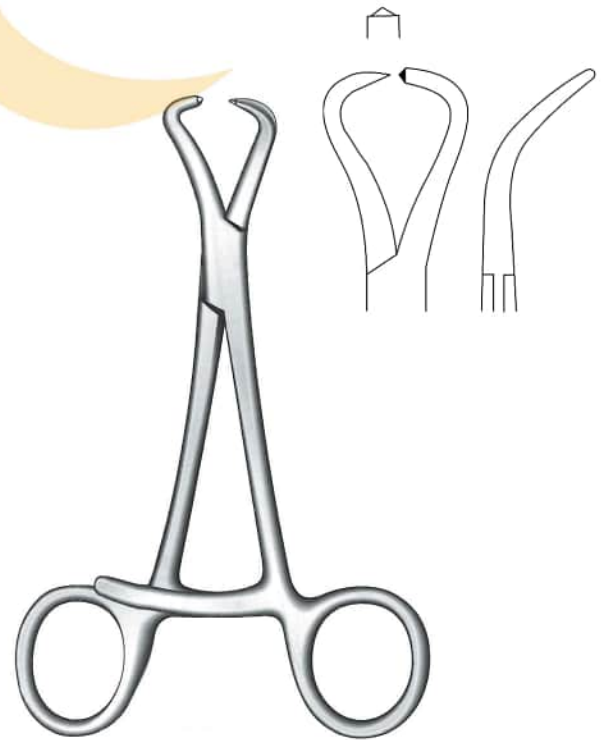

MO-13-771 14 cm / 5 1/2"
MO-13-772 16.5 cm / 6 1/2"
Curved
Bone reduction forceps

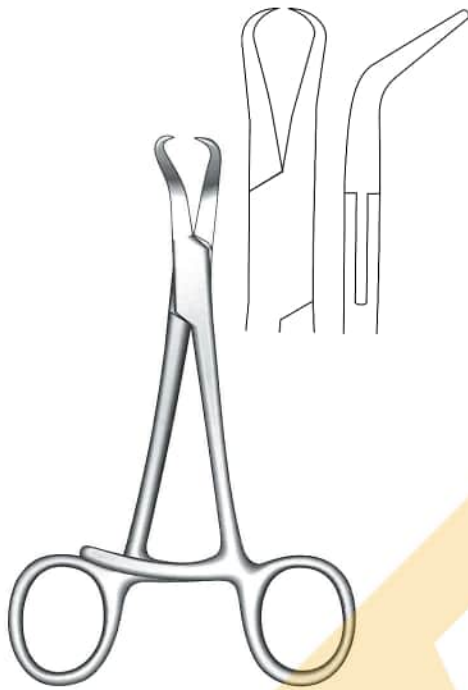

Stagbeetle
MO-13-773
12 cm / 4¾"
Bone reduction forceps Curved,
pointed tips

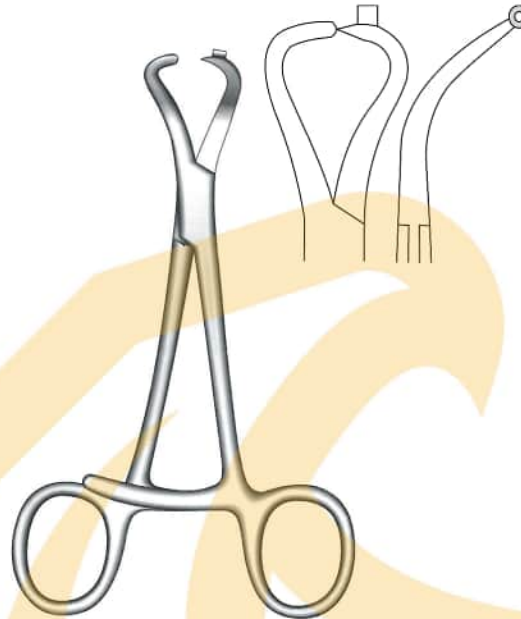

MO-13-774
13 cm / 5¼"
Bone holding forceps
Curved, with 1.6 mm k-wire guide

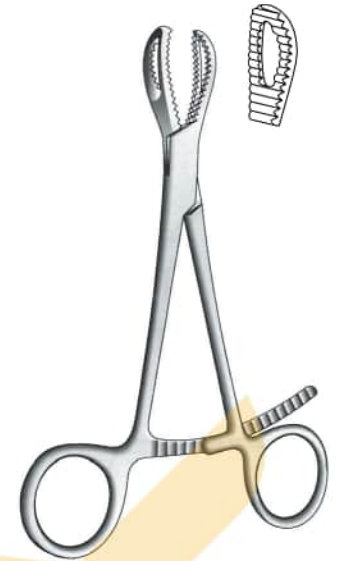

MO-13-1974
Bone holding forceps

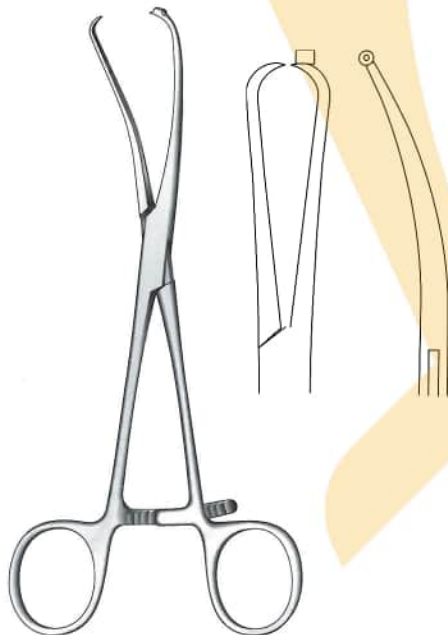

MO-13-775
17 cm / 6¾"
Bone holding forceps
Curved, with 1.1 mm k-wire guide

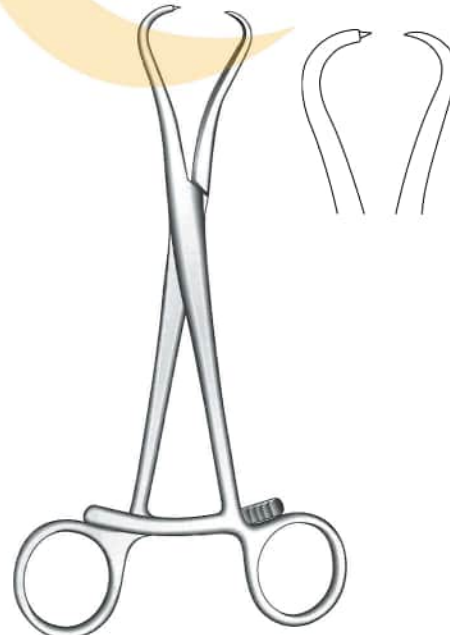

MO-13-2410 15 cm / 6"
MO-13-2412 17.5 cm / 7"
MO-13-2414 20 cm / 8"

Orthopedic

Bone Holding & Reduction Forceps

Knochenhaltezaugen

Pinzas para huesos



MO-13-776
12.5 cm / 5"

Bone holding forceps
Serrated with pointed tips
Curved

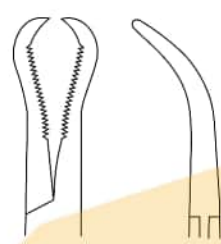

MO-13-777
14 cm / 5 1/2"



Reill
MO-13-778
17.5 cm / 7"
Bone reposition forceps
curved, pointed tips

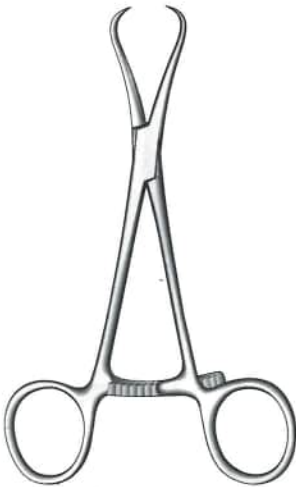

Steinhauser
MO-13-1420
13 cm / 5"

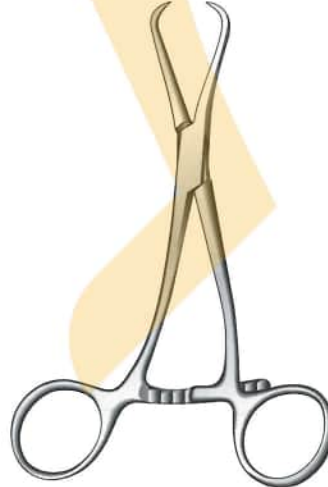

Steinhauser
MO-13-1425
13 cm / 5"

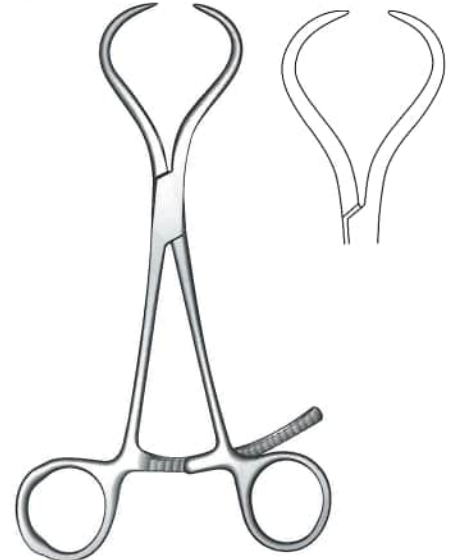

MO-13-1430
16 cm / 6 1/4"
Bone fragment forceps



MO-13-1680 15 cm / 6"
MO-13-1681 18 cm / 7"
MO-13-779 20 cm / 8"
MO-13-1682 30 cm / 12"
Bone reduction forceps

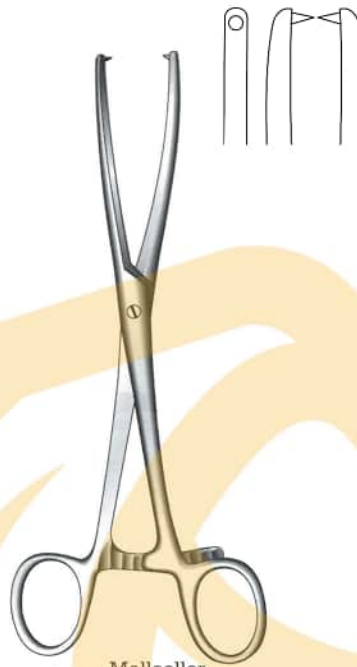

Malleolar
MO-13-780
21 cm / 8 1/4"
1 x 1 sharp points.
Grasping forceps for small bones

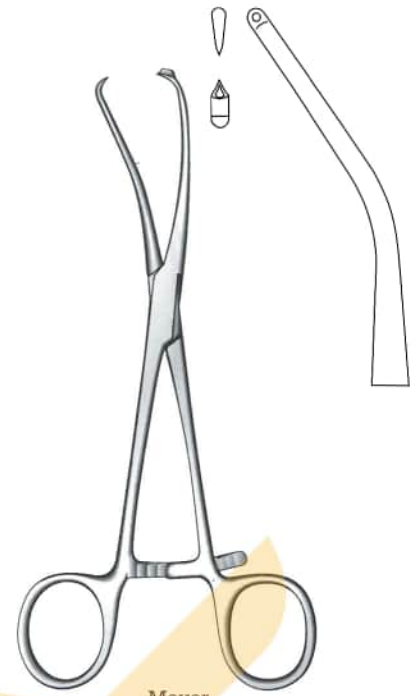

Meyer
MO-13-781
17 cm / 6 3/4"
Reposition forceps for gers,
with drill guide for Kirschner wires
up to diameter 1.0 mm

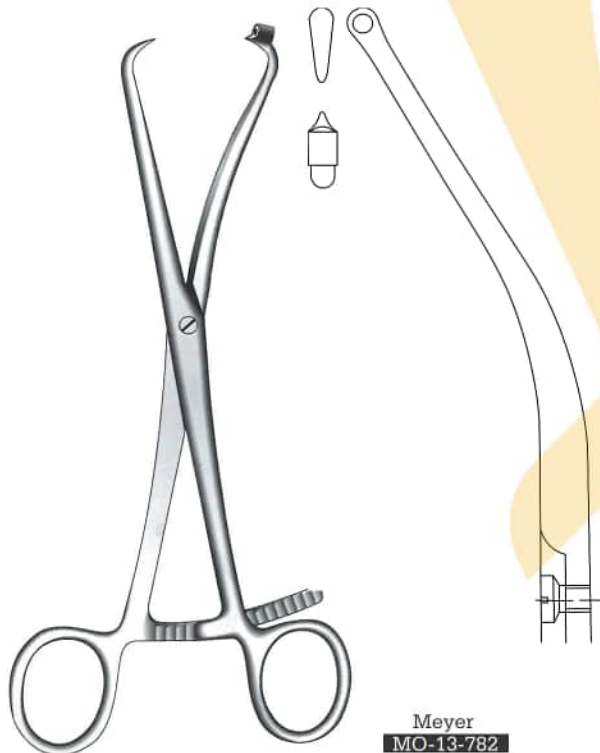

Meyer
MO-13-782
20.5 cm / 8"
Reposition forceps
with drill guide for kirschner
wires up to diameter 2.0 mm



MO-13-783
14 cm / 5 1/2"



Locke
MO-13-784
16 cm / 6"
Phalangeal forceps serrated jaws
1:1 Teeth

Orthopedic

Bone Holding & Reduction Forceps

Knochenhaltezaugen

Pinzas para huesos

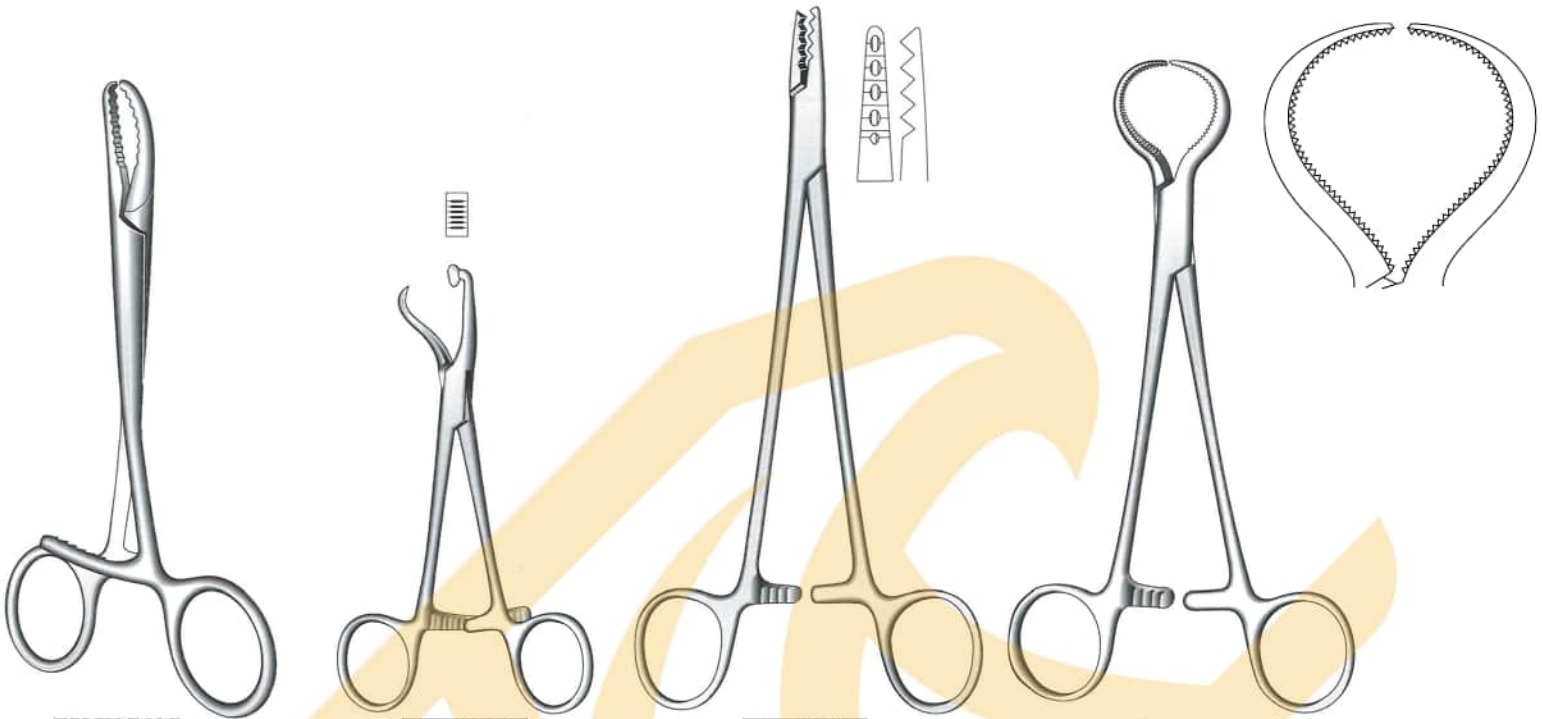

MO-13-785
14 cm / 5 1/4" small
Bone reduction forceps
curved, ratchet length: 1 1/4"

MO-13-786
12 cm / 4 3/4"

MO-13-2086
14 cm / 5"
MO-13-2087
19 cm / 7 1/2"

Lewin
MO-13-787
17.5 cm / 7"



Dingmann
MO-13-788
18.5 cm / 7 1/4"

Dingmann
MO-13-789
18.5 cm / 7 1/4"

Bircher-Ganske
20 cm / 8"

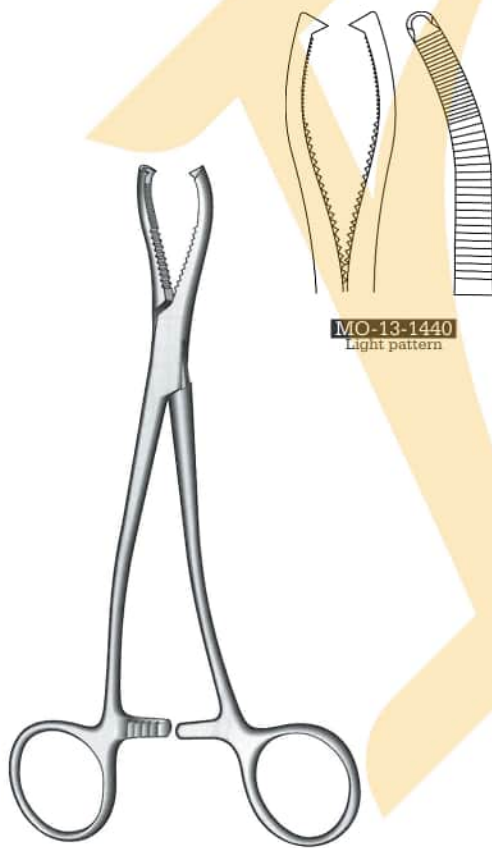

Jeter Van Sickels
18 cm / 7"
For sagittal split procedure

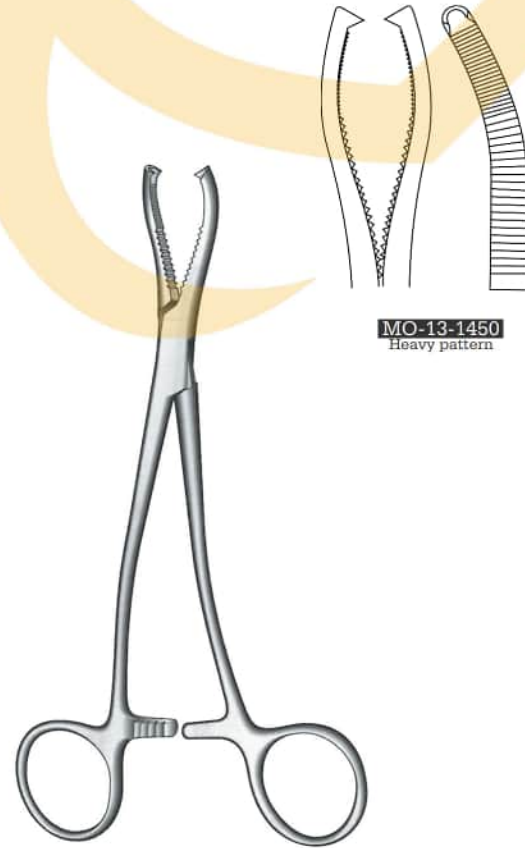

Jeter Van Sickels
18 cm / 7"
For sagittal split procedure

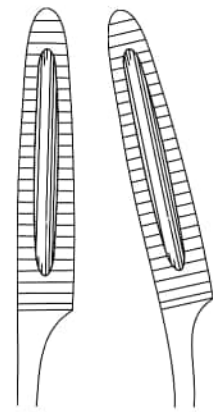

MO-13-790
Straight

MO-13-2090
Curved

Requestrum
20 cm / 8"



Van Buren
MO-13-791
23 cm / 9"



MO-13-792
20 cm / 8"



Langenbeck
MO-13-793
21 cm / 8 1/4"

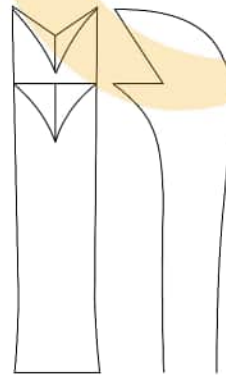

Fergusson
MO-13-794
21 cm / 8 1/4"

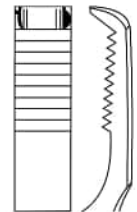

Frosch
MO-13-795
18 cm / 7"



Semb
MO-13-796
19 cm / 7½"
Without ratchet

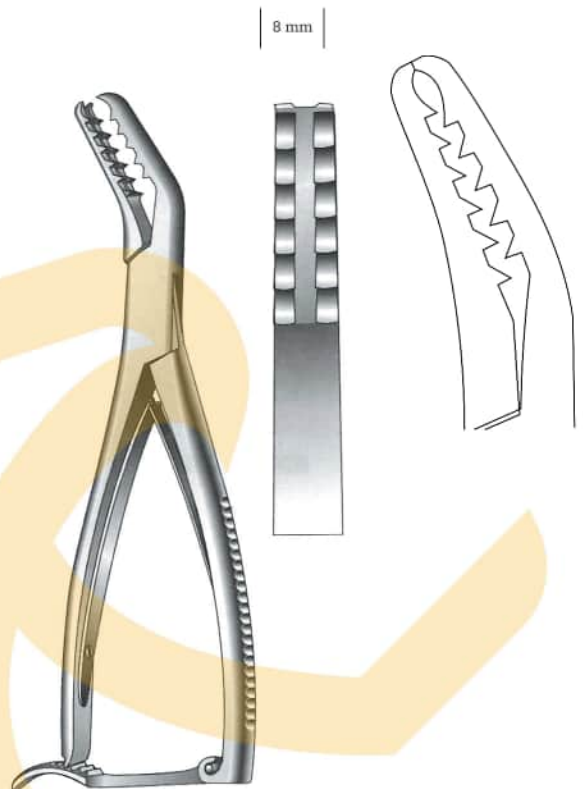

Semb
MO-13-797 19 cm / 7½"
Curved sideways
MO-13-2097 20 cm / 8"
Deep teeth with ratchet



Kern
MO-13-798 12 cm / 4¾"
MO-13-799 15 cm / 6"
MO-13-2098 17 cm / 6¾"
MO-13-299 21 cm / 8¼"
Without ratchet



Kern
MO-13-800 12 cm / 4¾"
MO-13-801 15 cm / 6"
MO-13-2503 17 cm / 6¾"
MO-13-2504 21 cm / 8¼"
MO-13-2505 23 cm / 9"
With ratchet

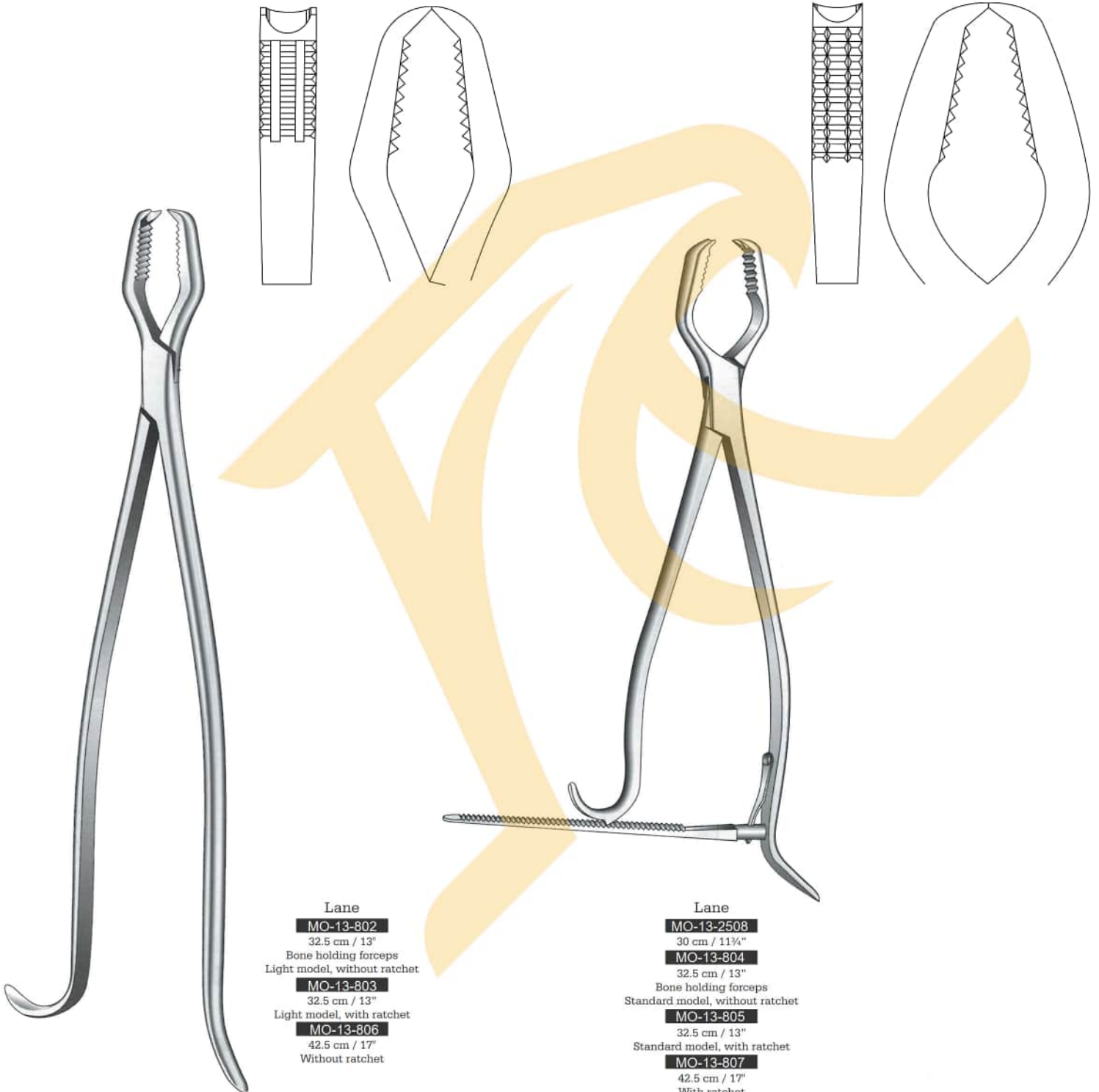

Lane
MO-13-802
 32.5 cm / 13"
 Bone holding forceps
 Light model, without ratchet
MO-13-803
 32.5 cm / 13"
 Light model, with ratchet
MO-13-806
 42.5 cm / 17"
 Without ratchet

Lane
MO-13-2508
 30 cm / 11¼"
MO-13-804
 32.5 cm / 13"
 Bone holding forceps
 Standard model, without ratchet
MO-13-805
 32.5 cm / 13"
 Standard model, with ratchet
MO-13-807
 42.5 cm / 17"
 With ratchet



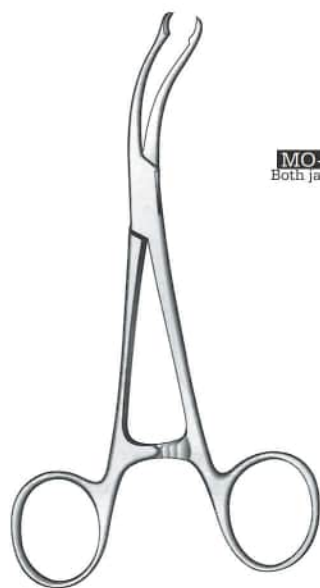

Verbrugge
16 cm / 6¼"

MO-13-1370
Both jaws serrated



MO-13-1371
1 jaw serrated 1
jaw plain



Verbrugge Prehenseur

MO-13-1375 18 cm / 7"
MO-13-1376 24 cm / 9½"
MO-13-1377 26 cm / 10¼"
MO-13-1378 28 cm / 11"
Serrated jaws

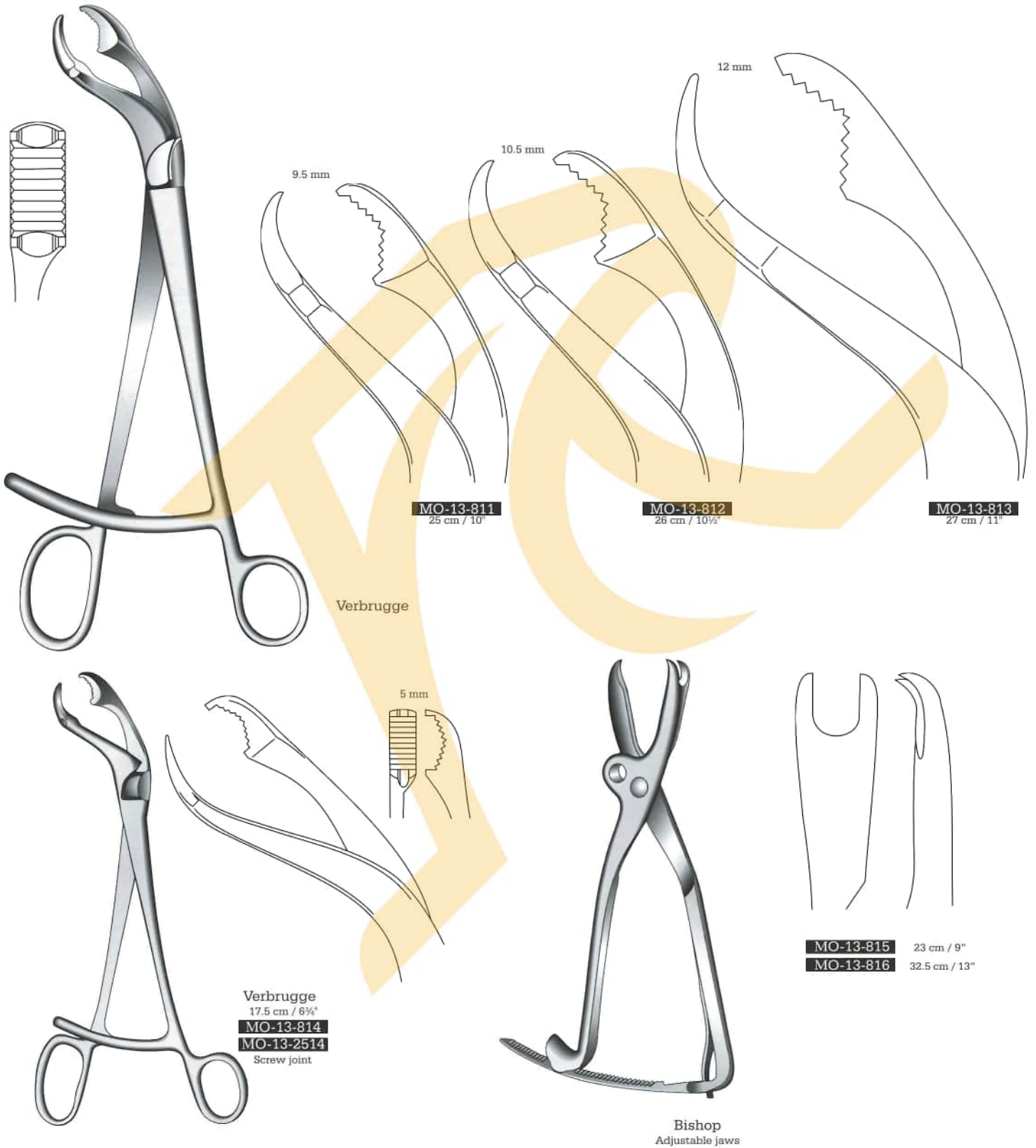

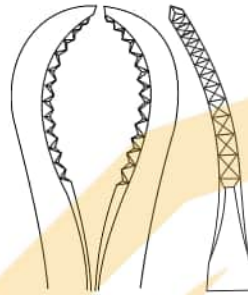

MO-13-817
 16 cm / 6 1/4"

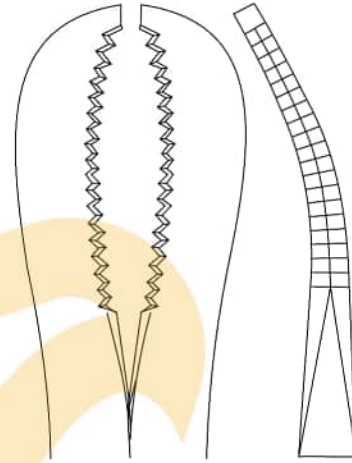

MO-13-818
 24 cm / 9 1/2"



Patella Forceps
MO-13-819
 18 cm / 7"
 2 x 2 sharp teeth
 with speed lock



Ollier
MO-13-1460 19 cm / 7 1/2"
MO-13-1461 22 cm / 8 3/4"
MO-13-1462 27 cm / 10 1/4"

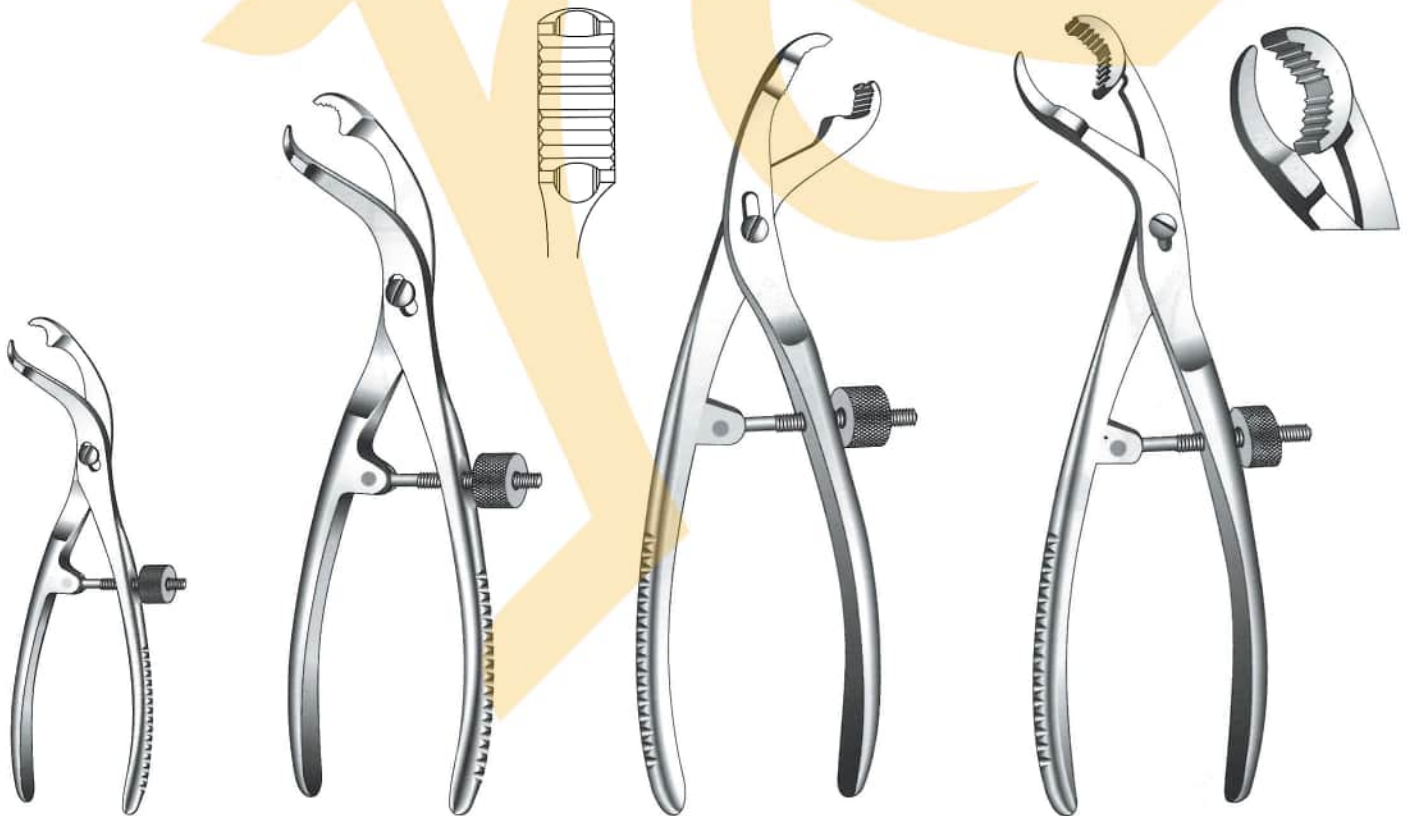
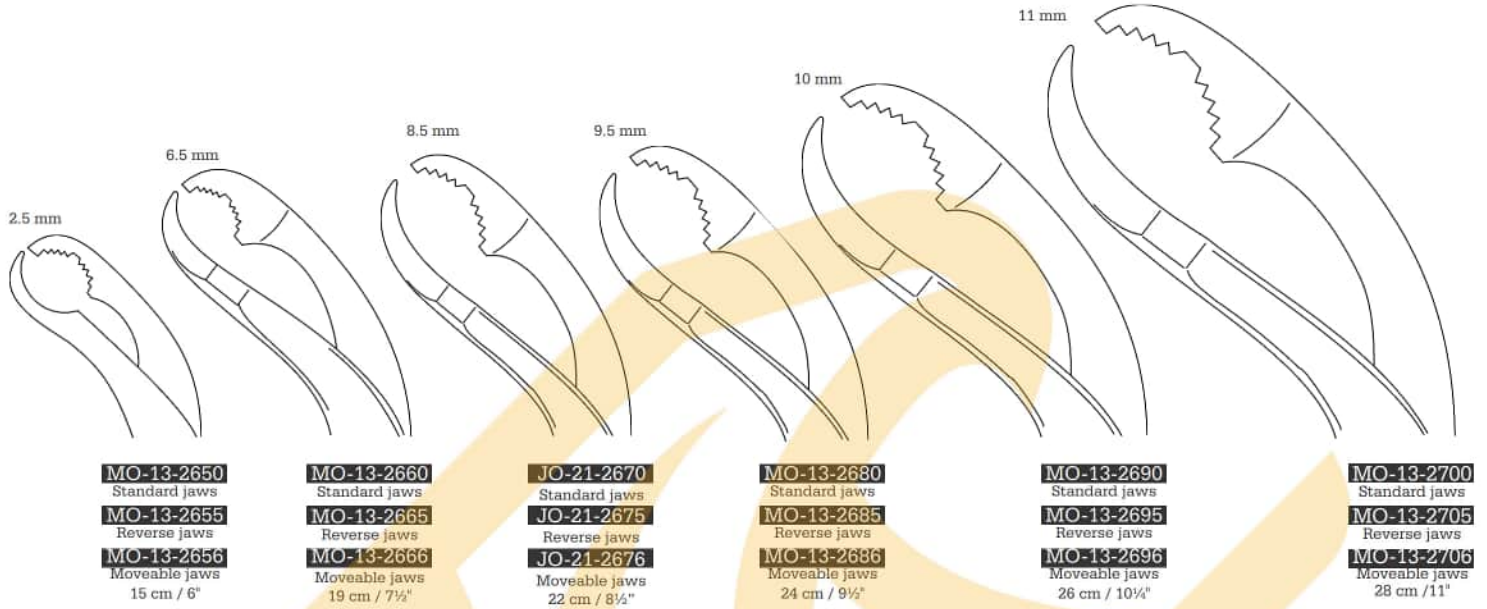

Mini
MO-13-2720
12 cm / 4¾"
Special size

Self-Centering Forceps
Standard jaws

Self-Centering Forceps
With thread fixation
Reverse jaws

Verbrugge
28 cm / 11"
With moveable jaws

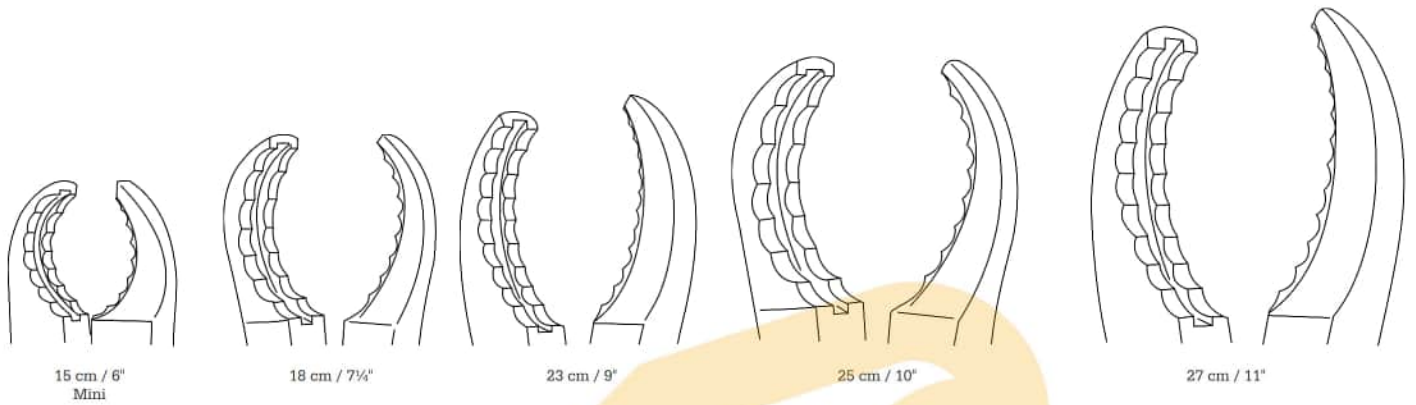

15 cm / 6"
 Mini

18 cm / 7 1/4"

23 cm / 9"

25 cm / 10"

27 cm / 11"



Ulrich
 MO-13-2725 13 cm / 5", Mini
 MO-13-825 15 cm / 6"
 MO-13-826 18 cm / 7 1/4"
 MO-13-827 23 cm / 9"
 MO-13-828 25 cm / 10"
 MO-13-829 27 cm / 11"
 Straight



Ulrich
 MO-13-2730 13 cm / 5", Mini
 MO-13-2731 15 cm / 6"
 MO-13-2732 18 cm / 7 1/4"
 MO-13-2733 23 cm / 9"
 MO-13-2734 25 cm / 10"
 MO-13-2735 27 cm / 11"
 Angled



Ulrich
 MO-13-831
 27 cm / 11"
 Self-retaining forceps
 angular, moveable jaw

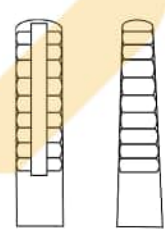

With speed lock
 and swivel jaw

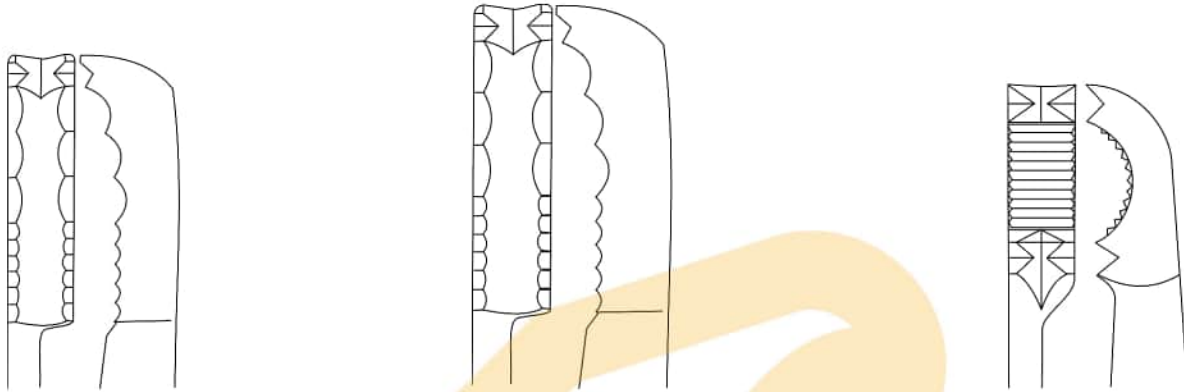

Farabeuf

MO-13-2740 19 cm / 7½"
MO-13-2743 23 cm / 9"
MO-13-2746 26 cm / 10¼"
Adjustable



Farabeuf Lambotte

MO-13-2750 19 cm / 7½"
MO-13-2752 23 cm / 9"
MO-13-2756 26 cm / 10¼"
Adjustable



Tuffier

MO-13-835
27 cm / 10½"
Adjustable

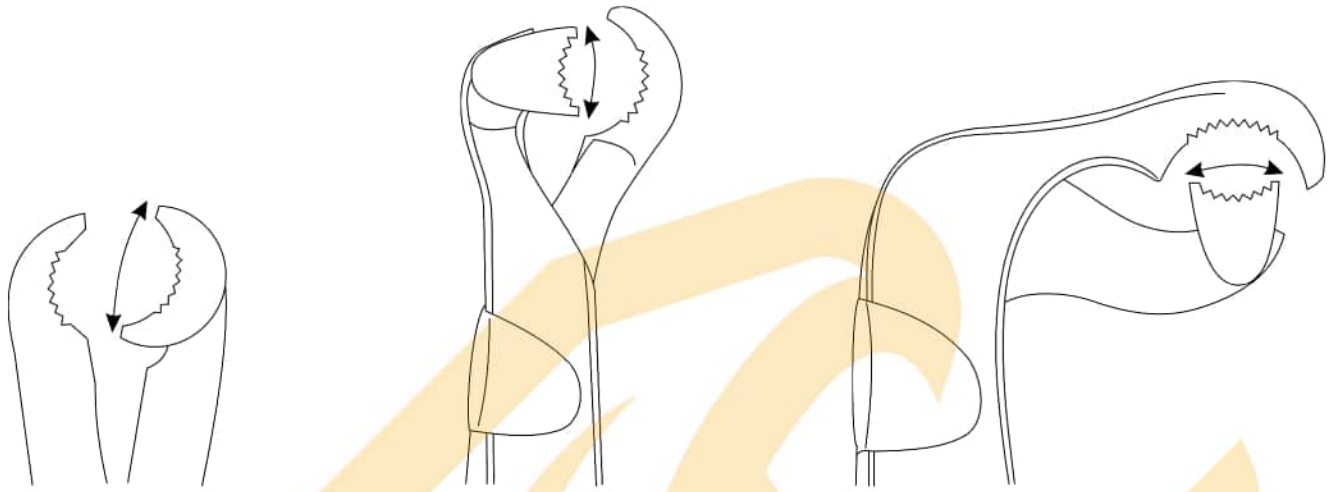

Lambotte
 MO-13-836 22 cm / 8 3/4"
 MO-13-837 27 cm / 10 1/2"
 MO-13-838 30 cm / 12"
 Adjustable



Lambotte
 MO-13-839 22 cm / 8 3/4"
 MO-13-840 26 cm / 10 1/4"
 MO-13-841 33 cm / 13"



Lambotte
 MO-13-842 19 cm / 7 1/2"
 MO-13-843 23 cm / 9"
 MO-13-844 26 cm / 10 1/4"

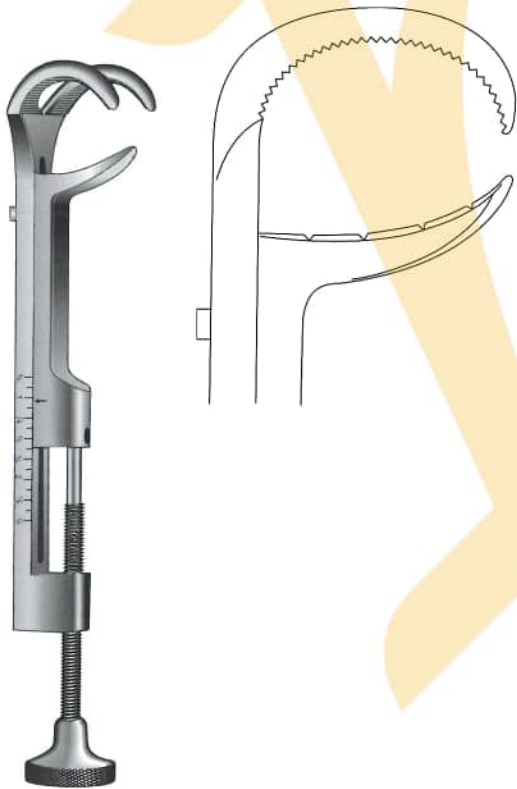
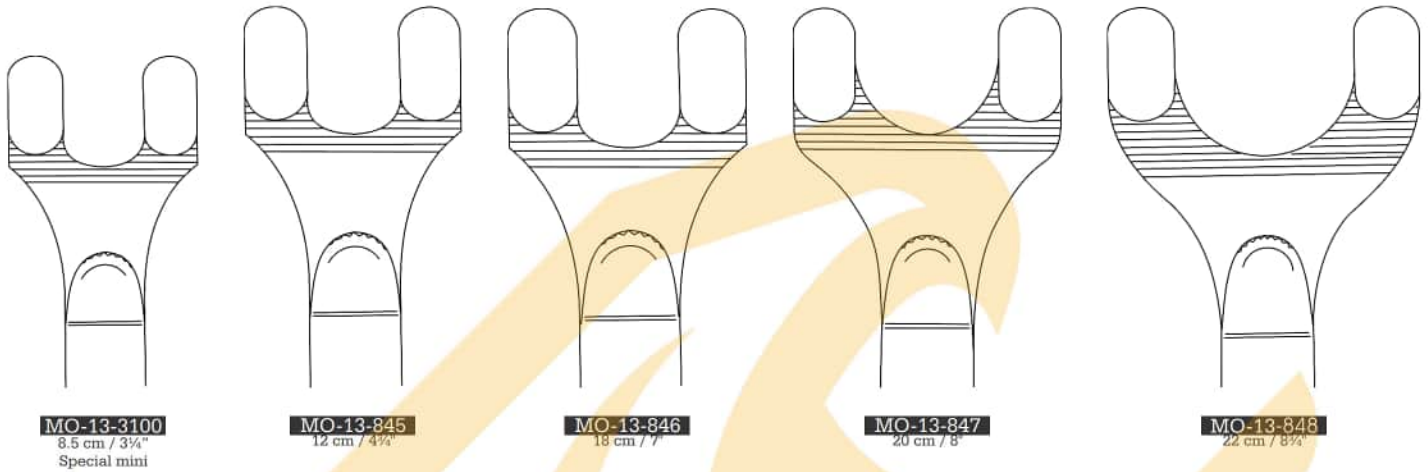

Gerster - Lowmann
1 x 2 jaws

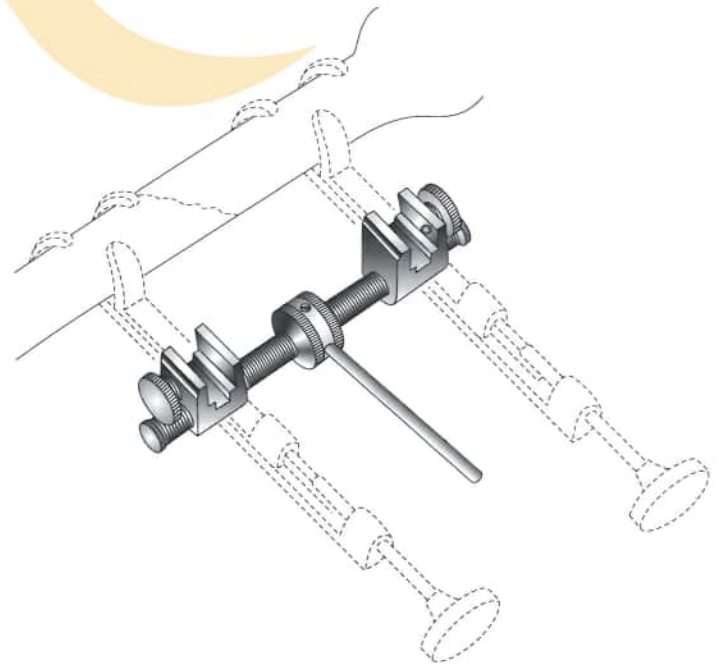

Gerster
MO-13-849

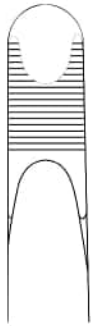

MO-13-850
 12 cm / 4 3/4"

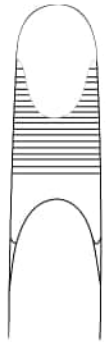

MO-13-851
 18 cm / 7 1/4"

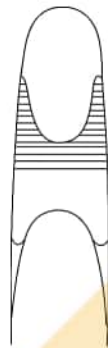

MO-13-852
 20 cm / 8"

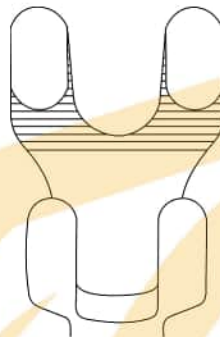

MO-13-853
 18.5 cm / 7 3/8"

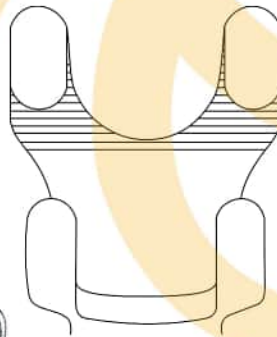

MO-13-854
 20 cm / 8"



Lowmann
 Bone clamp
 1 x 1 jaws



Lowmann
 Bone clamp
 2 x 2 jaws



Lowman Høglund
MO-13-1700 12 cm / 4 3/4"
MO-13-1701 18 cm / 7 1/4"
MO-13-1702 20 cm / 8"
 Moveable jaw



MO-13-2760 19 cm / 7½"
MO-13-2761 23 cm / 9"
MO-13-2762 25 cm / 10"



MO-13-2765 23 cm / 9"
MO-13-2766 25 cm / 10"

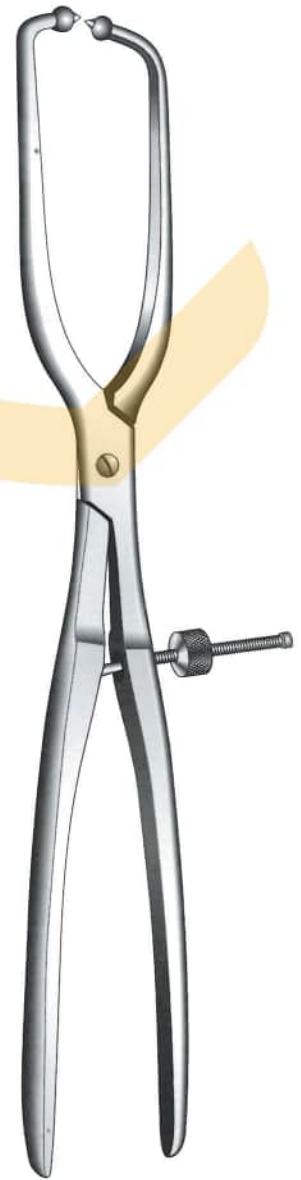

MO-13-2770
40 cm / 16"



MO-13-2775
40 cm / 16"

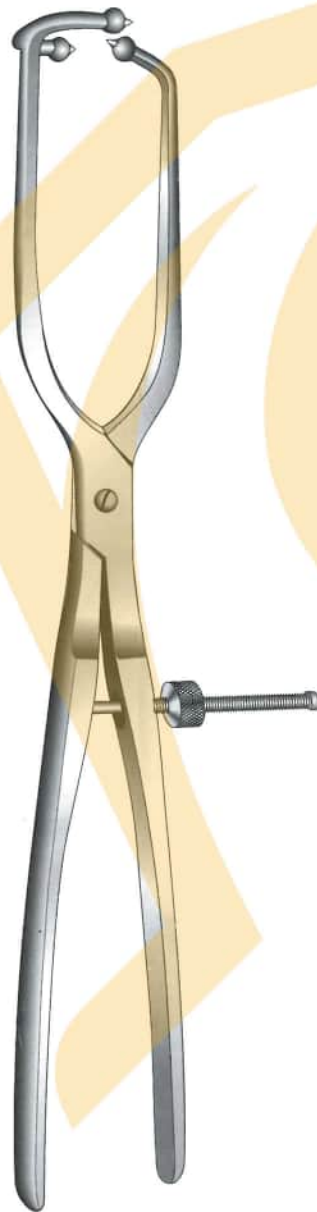

MO-13-2780
40 cm / 16"

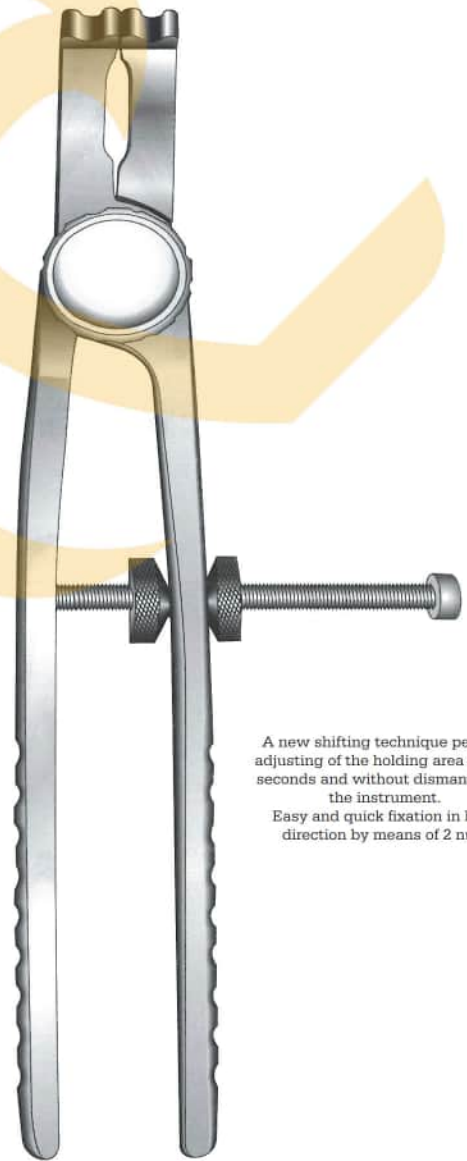

MO-13-2785
Reposition forceps

A new shifting technique permits adjusting of the holding area within seconds and without dismantling the instrument.
Easy and quick fixation in both direction by means of 2 nuts

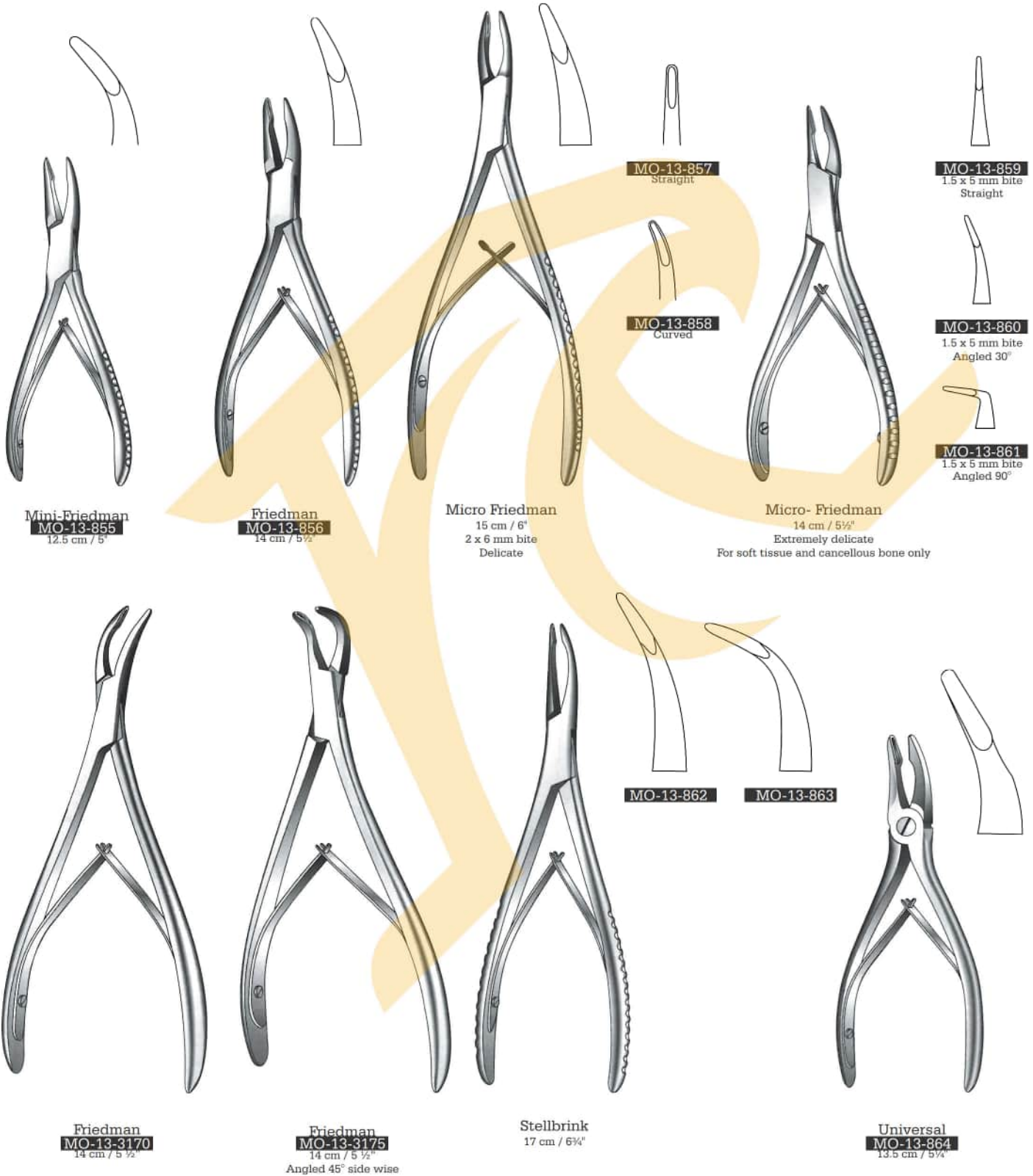



Mead
MO-13-865
16.5 cm / 6 1/2"



Mead
MO-13-1705
16.5 cm / 6 1/2"



Mead
MO-13-866
16.5 cm / 6 1/2"



Cleveland
MO-13-867
14.5 cm / 5 1/2"

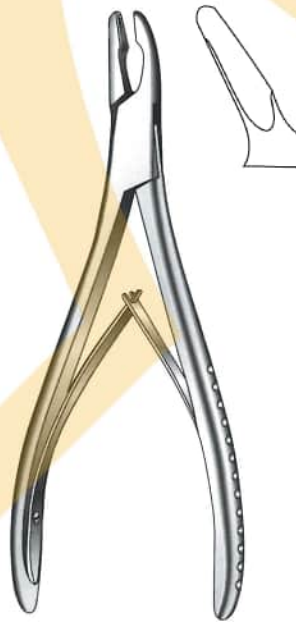

Cleveland
MO-13-868
17 cm / 6 3/4"



Hartmann
MO-13-869
18.5 cm / 7 1/4"



Jansen
18 cm / 7"



MO-13-870



MO-13-871



MO-13-872



Jansen
18 cm / 7"



MO-13-873



MO-13-874

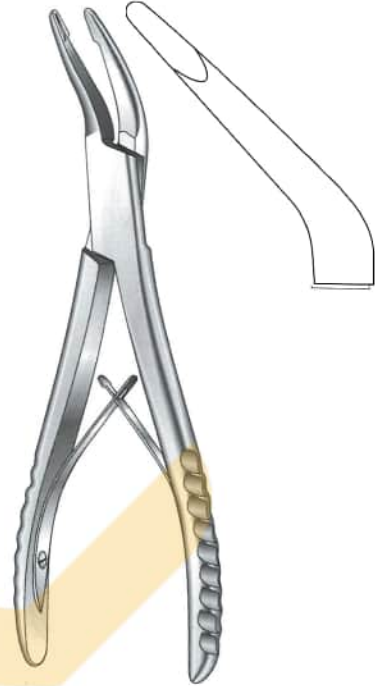

Marchac
MO-13-1710
18 cm / 7"



Blumenthal
15 cm / 6"



MO-13-875



MO-13-876

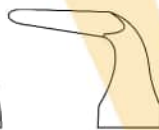

MO-13-877



Luer
15 cm / 6"



MO-13-878



MO-13-879



MO-13-880

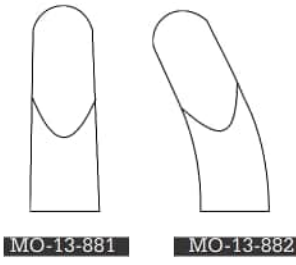

MO-13-881

MO-13-882

Luer
 17 cm / 6 3/4"

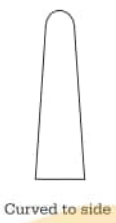
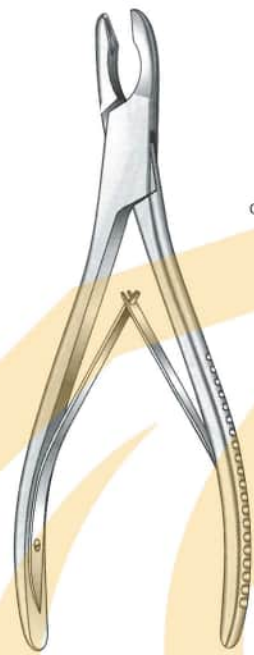

Curved to side

Hakansson
 MO-13-883
 17 cm / 6 3/4"



Alexander
 MO-13-884
 14 cm / 5 1/2"

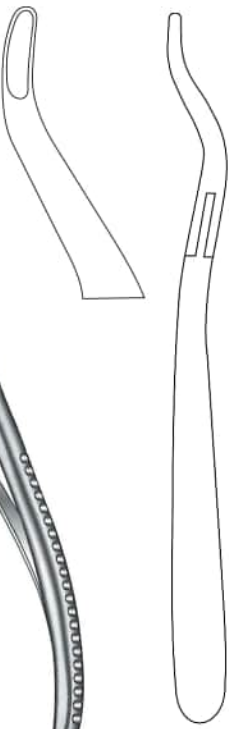

Jansen
 MO-13-885
 19 cm / 7 1/2"

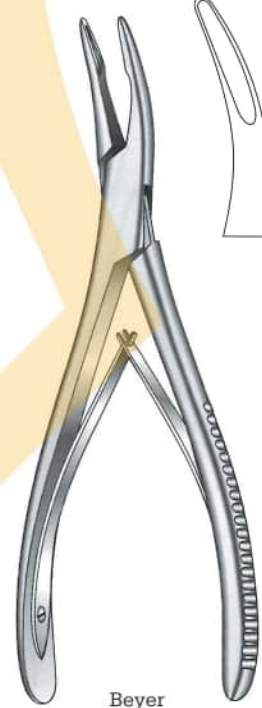

Beyer
 MO-13-886
 18 cm / 7"

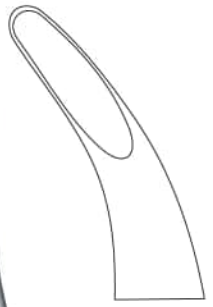

Olivecrona
 MO-13-887
 20.5 cm / 8"

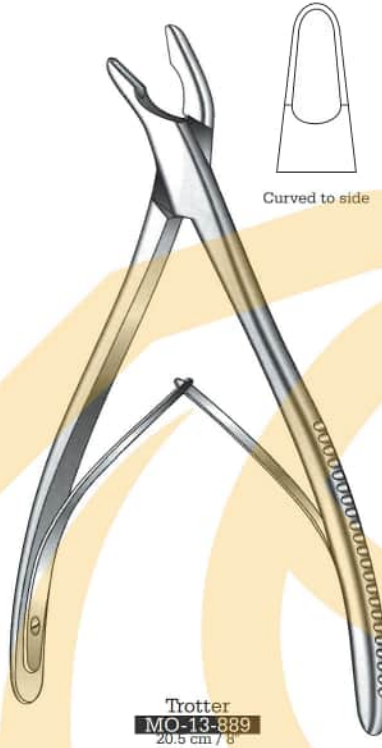



Lempert
2.5 mm bite

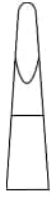

MO-13-1715
16 cm / 6 1/4"

MO-13-894
19 cm / 7 1/2"
Straight



MO-13-1716
16 cm / 6 1/4"

MO-13-895
19 cm / 7 1/2"
Curved

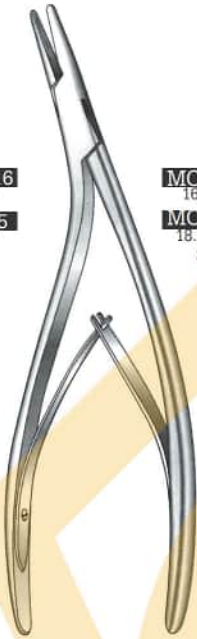

Juers-Lempert
Straight jaws on curved
handles, delicate, 2.5 mm bite



MO-13-1725
16 cm / 6 1/4"

MO-13-1726
18.5 cm / 7 1/4"
Straight



MO-13-1727
16 cm / 6 1/4"

MO-13-1728
18.5 cm / 7 1/4"
Curved

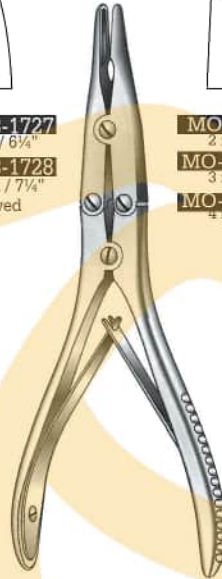

Bohler
15 cm / 6"



MO-13-896
2 mm tip

MO-13-1730
3 mm tip

MO-13-1732
4 mm tip



MO-13-897
2 mm tip

MO-13-1731
3 mm tip

MO-13-1733
4 mm tip



Zaifal-Jansen
MO-13-898
15 cm / 7"



Mayfield
MO-13-899
17 cm / 6 3/4"



Beyer
18 cm / 7"



MO-13-2790
Straight



MO-13-2791
Curved



Ruskin
Delicate



MO-13-2800 2 mm

MO-13-2801 3 mm

MO-13-2802 4 mm
15 cm / 6"

MO-13-2810 2 mm

MO-13-2811 3 mm

MO-13-2812 4 mm

MO-13-2813 6 mm

MO-13-2814 8 mm
17.5 cm / 7"

MO-13-2820 2 mm

MO-13-2821 3 mm

MO-13-2822 4 mm

MO-13-2823 6 mm

MO-13-2824 8 mm
20 cm / 8"
Straight



MO-13-2830 2 mm

MO-13-2831 3 mm

MO-13-2832 4 mm
15 cm / 6"

MO-13-2840 2 mm

MO-13-2841 3 mm

MO-13-2842 4 mm

MO-13-2843 6 mm

MO-13-2844 8 mm
17.5 cm / 7"

MO-13-2850 2 mm

MO-13-2851 3 mm

MO-13-2852 4 mm

MO-13-2853 6 mm

MO-13-2854 8 mm
20 cm / 8"
Curved



Ruskin
MO-13-904
23 cm / 9"

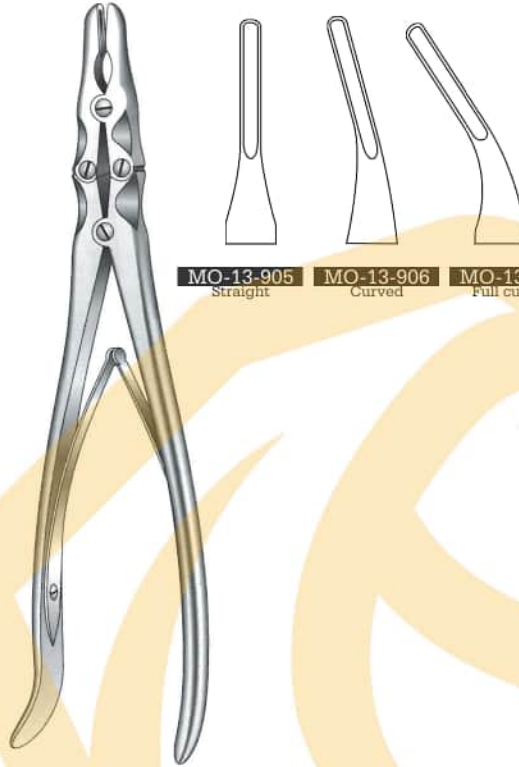

MO-13-905 Straight
MO-13-906 Curved
MO-13-907 Full curved

Smith-Peterson
24 cm / 9½"
3 x 16 mm bite
Laminectomy rongeur



Marquard
MO-13-908
20 cm / 8"



MO-13-909 2 x 13 mm bite
MO-13-910 3 x 13 mm bite

Kleinert-Kutz
15 cm / 6"
Synovectomy rongeur
Slight curve, delicate

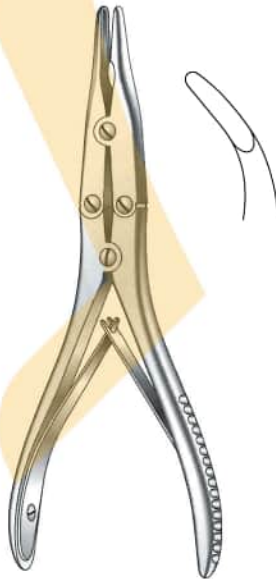

MO-13-911
15 cm / 6"
3 x 8 mm bite
Full curved
Delicate

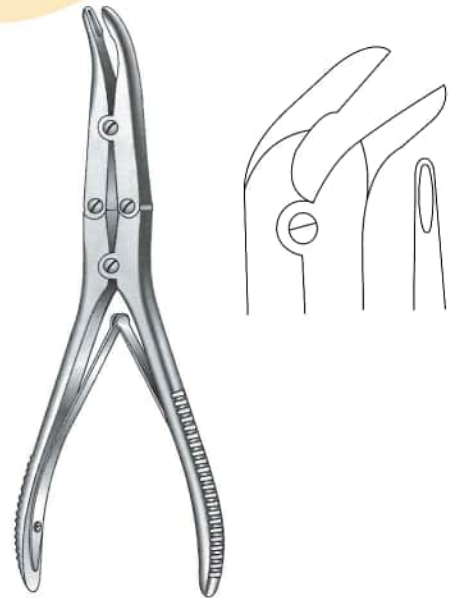

Kleinert-Kutz
MO-13-912
15 cm / 6"
2 x 10 mm bite
Synovectomy rongeur
Curved on side
Delicate

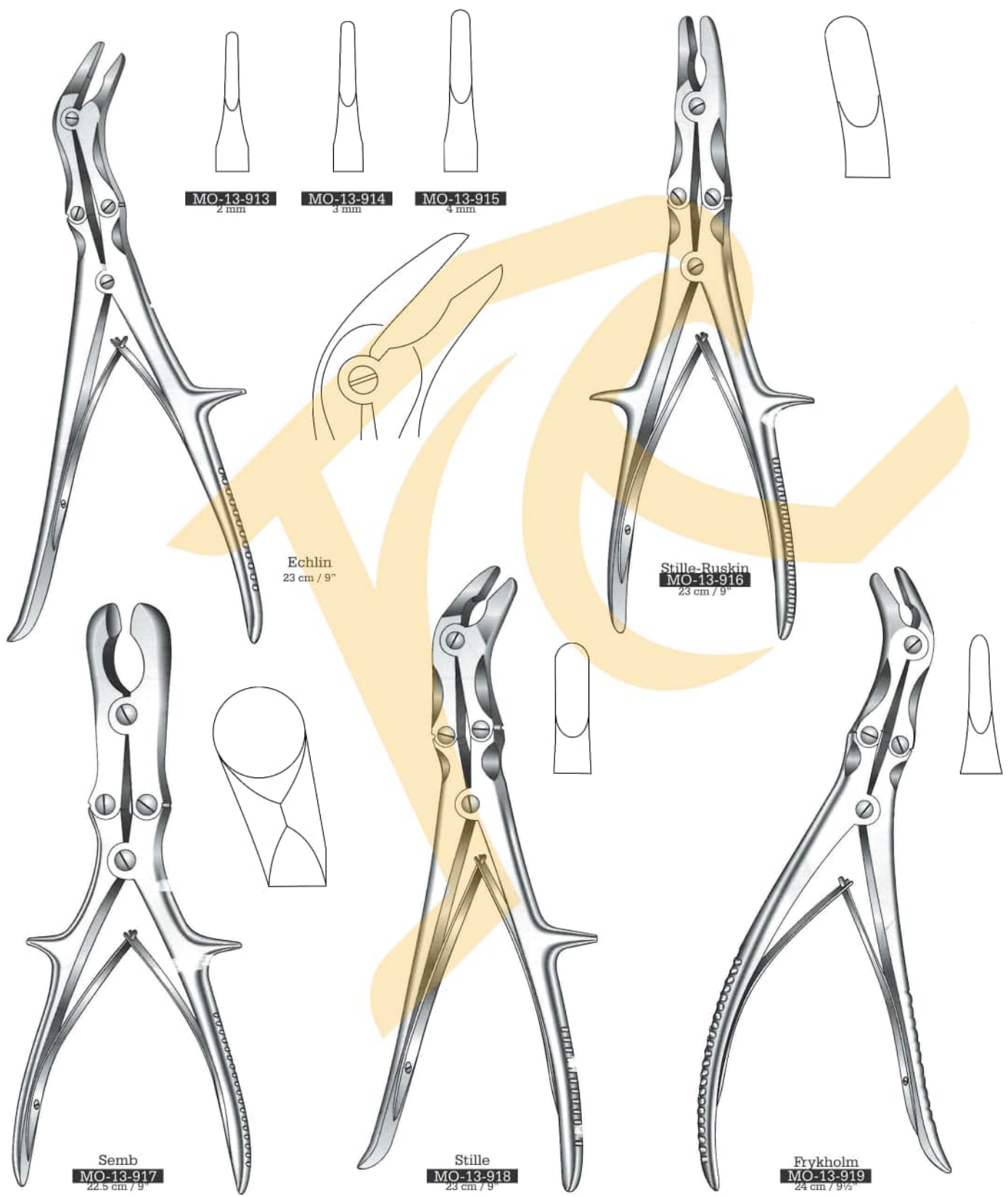



Leksell-Stille
24 cm / 9½"
Curved 15°



Leksell
23 cm / 9"
Curved 50°



MO-13-920
3 x 16 mm bite



MO-13-921
4 x 16 mm bite



MO-13-922
5 x 16 mm bite



MO-13-923
6 x 16 mm bite



MO-13-924
7 x 16 mm bite



MO-13-925
8 x 16 mm bite

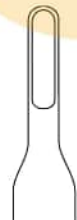

MO-13-926
3 x 13 mm bite



MO-13-927
4 x 13 mm bite



MO-13-928
5 x 13 mm bite



MO-13-929
6 x 13 mm bite



MO-13-930
7 x 13 mm bite



MO-13-931
8 x 13 mm bite

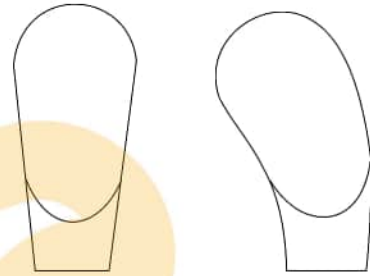

MO-13-934	23 cm / 9"	MO-13-936
MO-13-935	27 cm / 10½"	MO-13-937

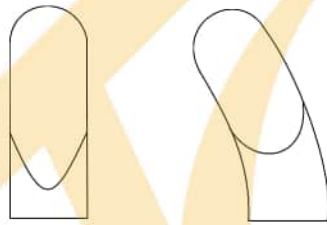

MO-13-2870	4 mm	MO-13-2890
MO-13-2872	6 mm	MO-13-2892
MO-13-2874	8 mm	MO-13-2894
MO-13-2876	10 mm	MO-13-2896
MO-13-2878	12 mm	MO-13-2898



Stille-Luer
 22 cm / 8½"
 8 mm



Stille-Luer

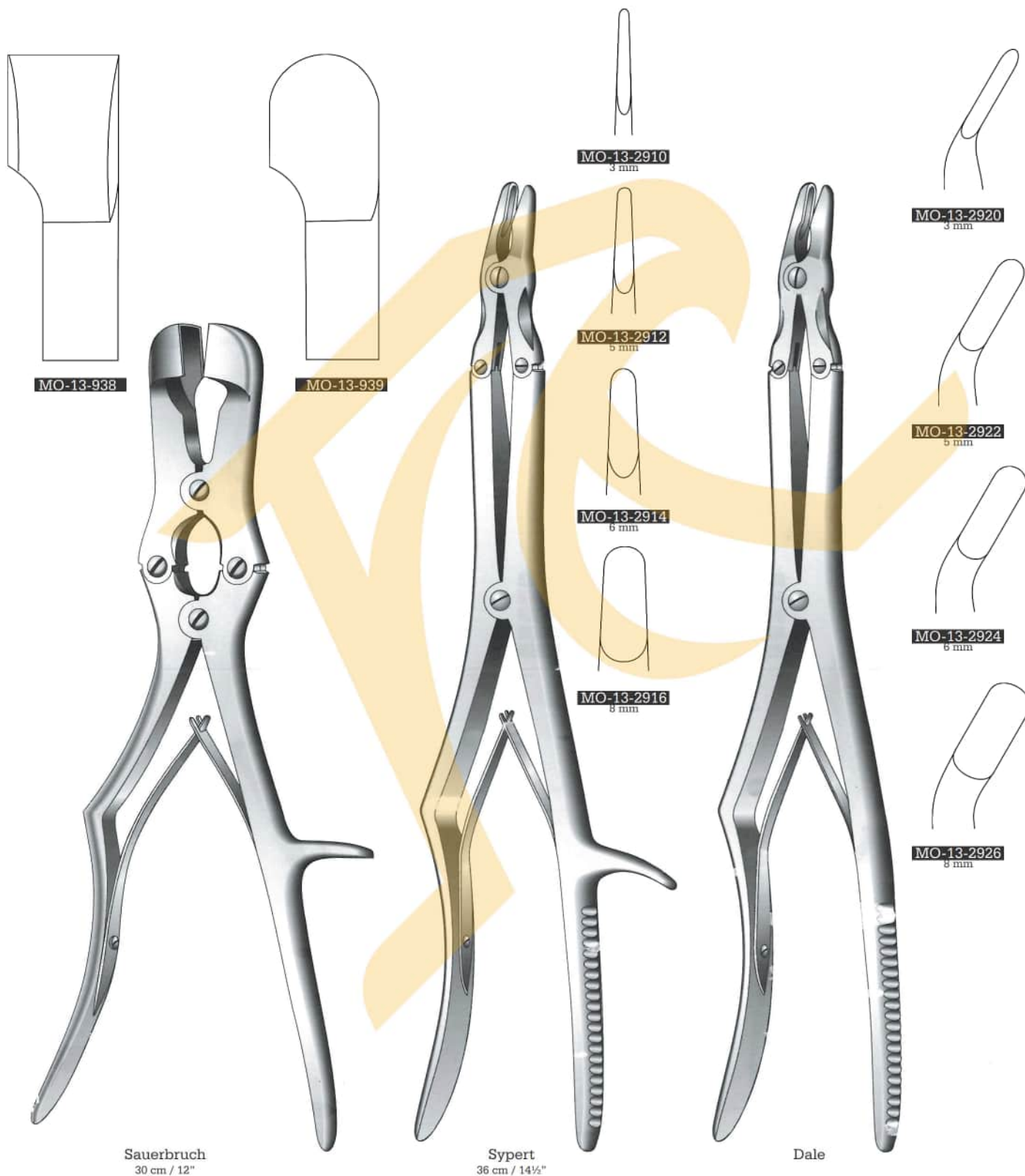

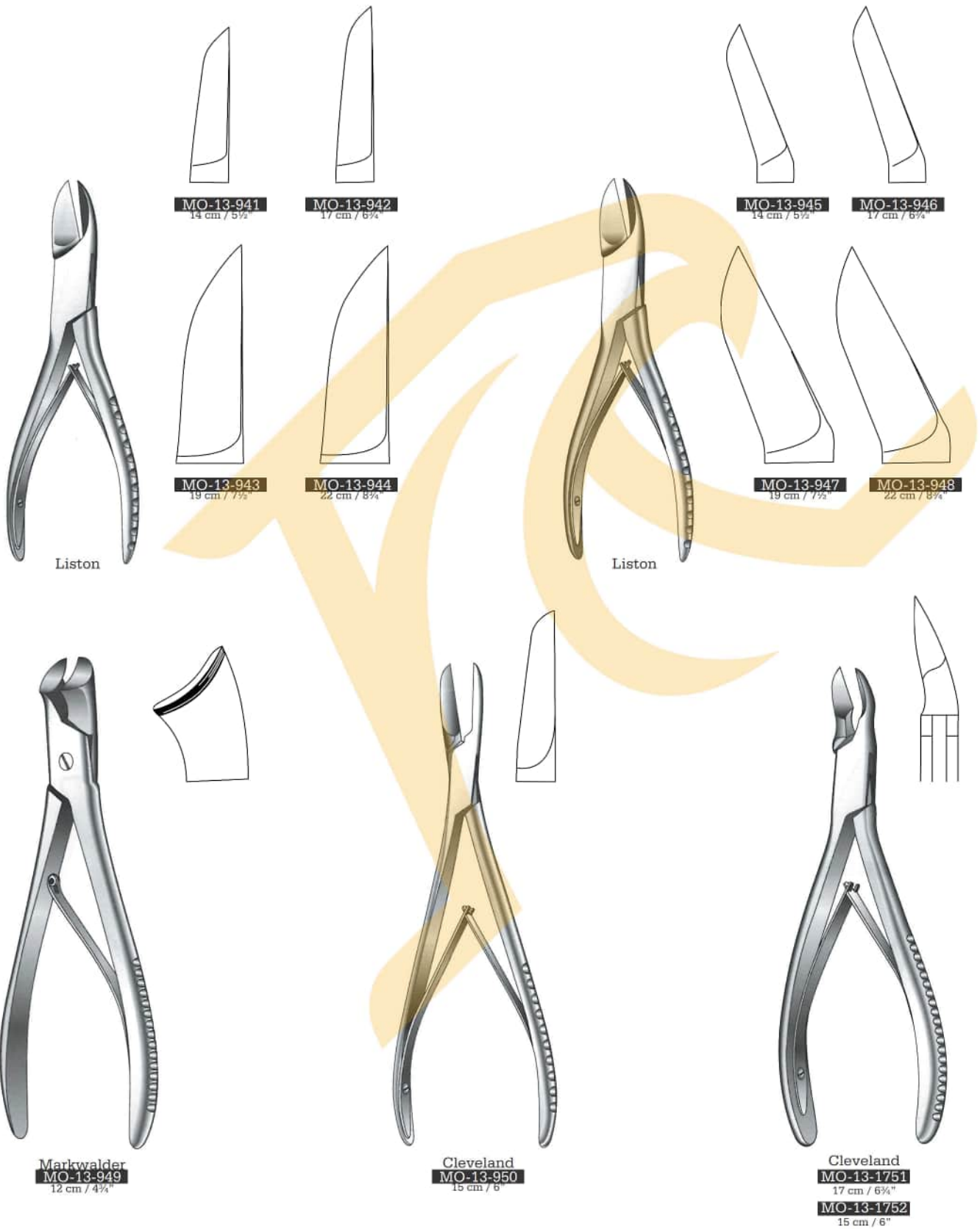

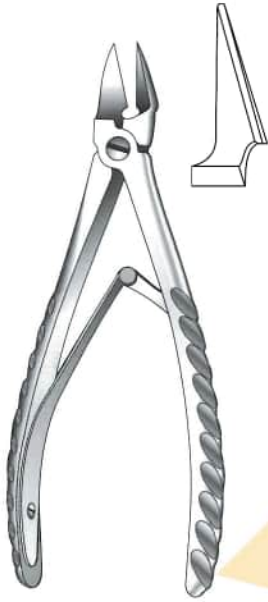

Stamm
MO-13-952
15 cm / 6"



Kazanjian
MO-13-953
18.5 cm / 7 1/4"

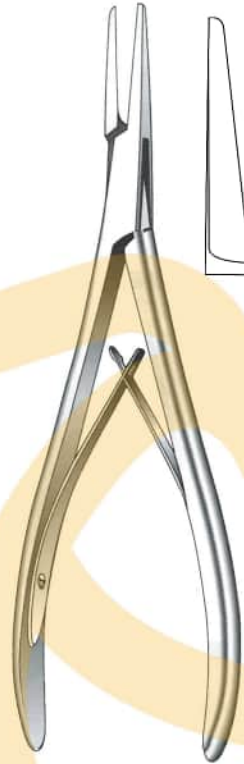

Tessier
MO-13-1755
20.5 cm / 8" Slim
pattern



Markwalder
MO-13-954
20 cm / 8"

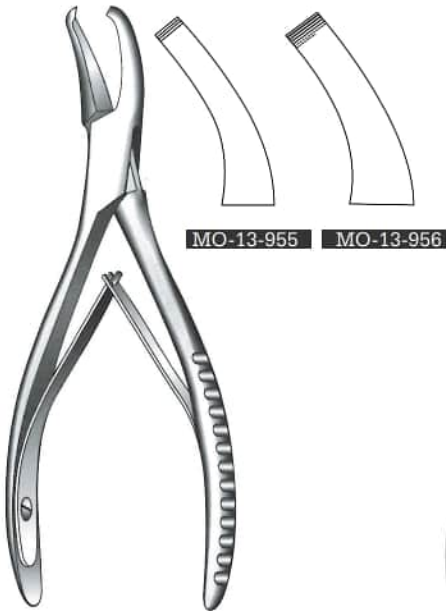

Cleveland
16 cm / 6 1/4"



Bohler
MO-13-957
15 cm / 5 3/4"



Bohler
MO-13-958
14.5 cm / 5 3/4"



Velpeau
MO-13-1760
24 cm / 9 1/2"



Bohler
MO-13-959
14.5 cm / 5 7/8"

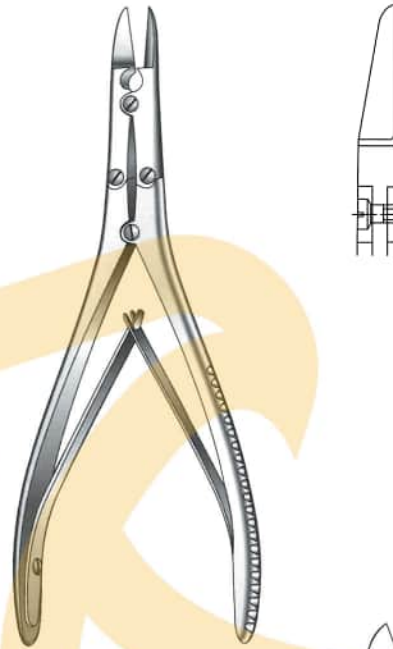

MO-13-960
17 cm / 6 3/4"



Mc Indoe
MO-13-961
17.5 cm / 7"

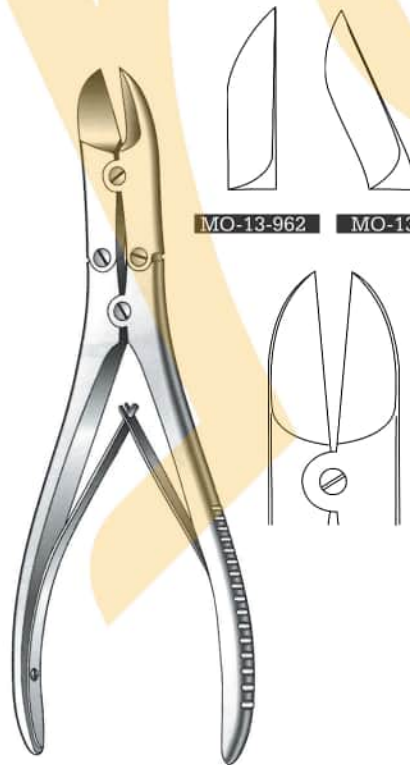

MO-13-962 MO-13-963

Ruskin-Liston
18.5 cm / 7 1/4"



Liston
MO-13-964
24 cm / 9 1/2"



Stille-Liston
MO-13-965
27 cm / 10½"

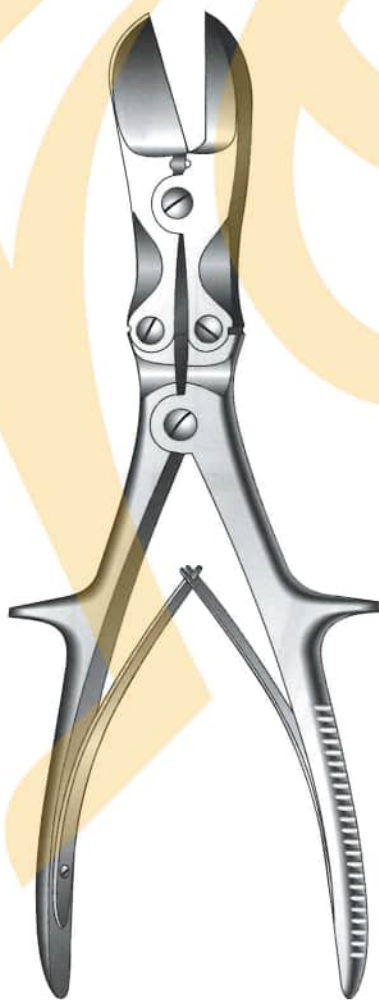

Stille-Liston
MO-13-966
27 cm / 10½"



Stille-Liston
MO-13-967
27 cm / 10½"

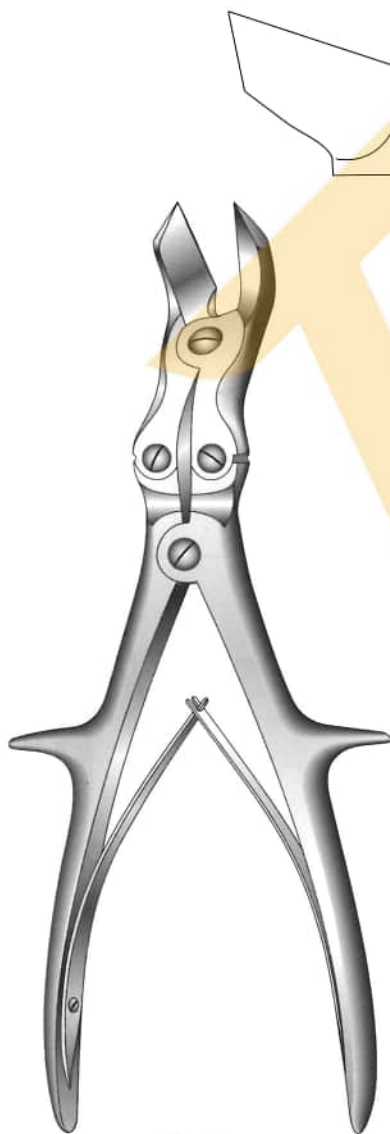

Liston-Key
MO-13-968
27 cm / 10 1/2"

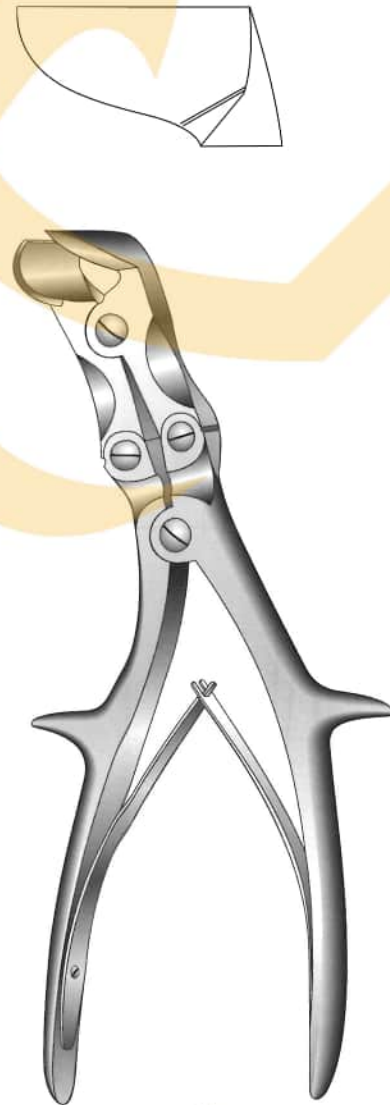

Semb
MO-13-969
24 cm / 9 1/2"

Instruments with Tungsten Carbide inserts

TC GOLD



TC Gold
MT-13-1030
15.5 cm / 6"



Corwin
TC Gold
MT-13-1031
16 cm / 6 1/4"



TC Gold
MT-13-970
15 cm / 6"



TC Gold
MT-13-971
20 cm / 8"



TC Gold
MT-13-972
18.5 cm / 7 1/4"
MT-13-1220
20 cm / 8"



TC Gold
MT-13-1210
Jet wire twister

Orthopedic

Wire Tightening pliers, Flat Nose Pliers
 Drahtspannierzangen, Flachzangen
 Tensor cierra-hilo, Alicates de pico plano



Instruments with Tungsten Carbide inserts
TC GOLD



TC Gold
MT-13-973
 17 cm / 6 3/4"

Holding forceps for cerclage wire, with lateral jaws to avoid wire slipping off



TC Gold
MT-13-974
 15 cm / 6"

Wire tightening pliers
 ligature pliers

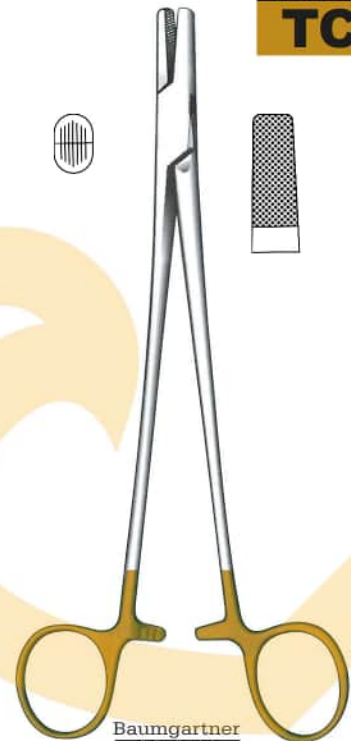

Baumgartner
 TC Gold
MT-13-975
 20 cm / 8"

Wire twister, ligature forceps



TC Gold
MT-13-976



TC Gold
MT-13-977



TC Gold
MT-13-978

18 cm / 7"
 Parallel grip



MO-13-979

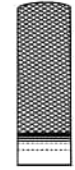

MO-13-980

18 cm / 7"
 Parallel grip



MO-13-981
 16 cm / 6 1/4"
 Heavy pattern



MO-13-982
 15 cm / 6"
 For bending & cutting



MO-13-983
 16.5 cm / 6 1/2"

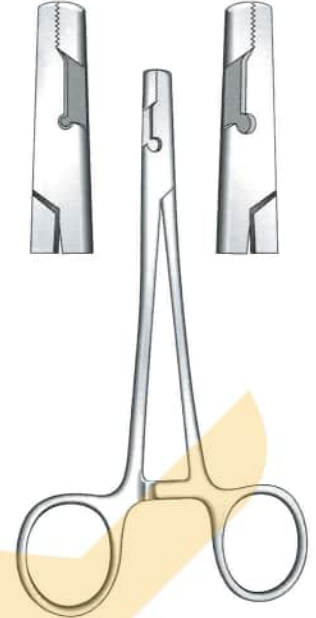

MO-13-1132
 Wire twister / Shear cutter
 cuts wire up to 18g, twisted double



17 cm / 6 3/4"

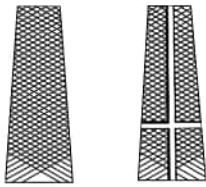

MO-13-984 **MO-13-985**
 With crosswise groove



Hakstock
MO-13-986
 16 cm / 6 1/4"
 With longitudinal groove

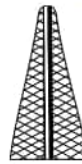

MO-13-987
 14 cm / 5 1/2"

Orthopedic

Flat Nose & wire Twisting pliers

Flachzangen, Draht-Kneifzangen

Alicates planos, Alicates para cortar alambre

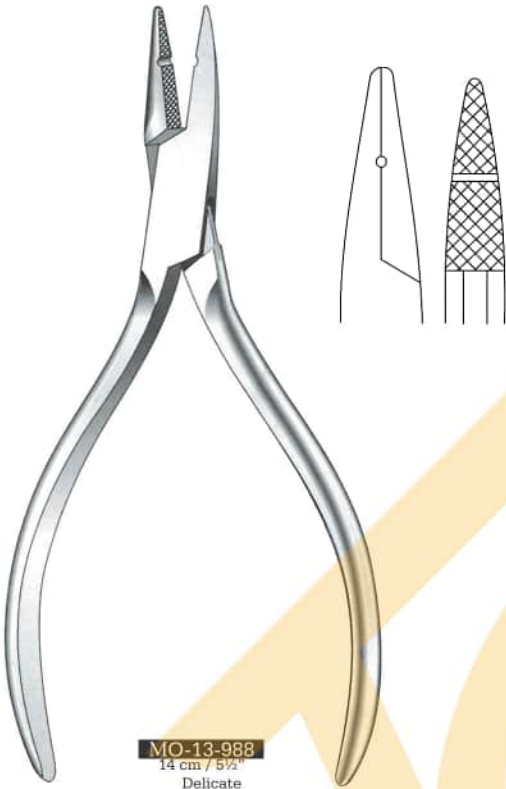

MO-13-988
14 cm / 5 1/2"
Delicate

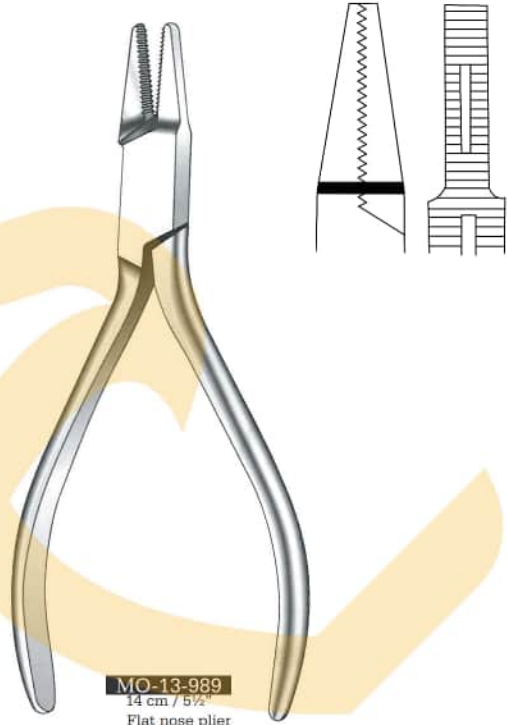

MO-13-989
14 cm / 5 1/2"
Flat nose plier
Broad

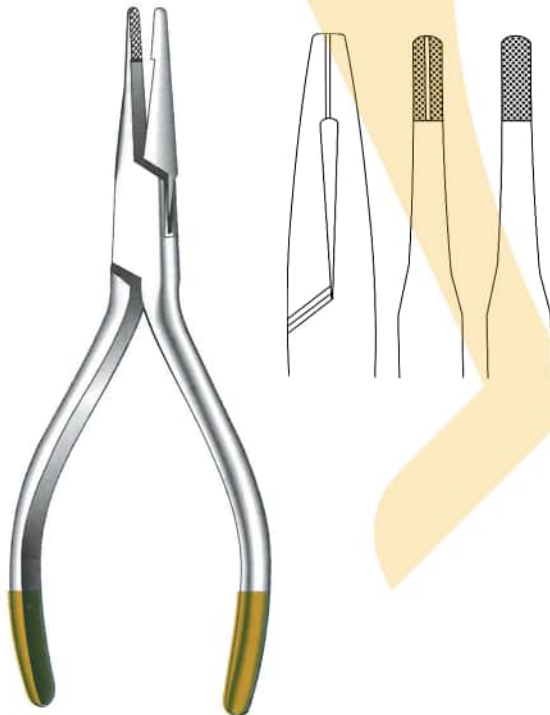

TC Gold
MT-13-990
14 cm / 5 1/2" 4
mm tip
Pin pulling plier

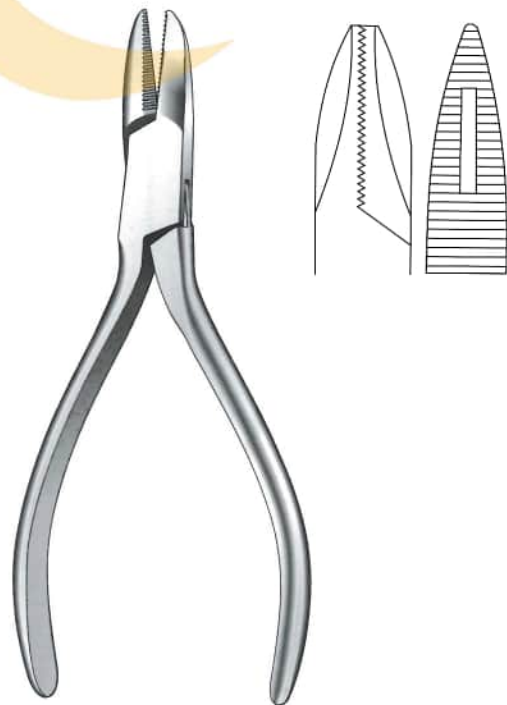

MO-13-991
14 cm / 5 1/2"
2 mm tip
Needle nose plier



MO-13-992
15 cm / 6"
Flat nose plier
2 mm tip for cerclage wire
Delicate

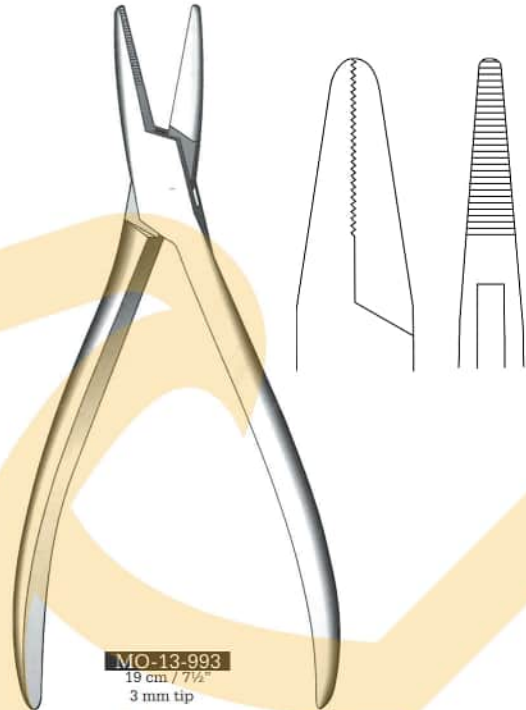

MO-13-993
19 cm / 7 1/2"
3 mm tip
Narrow nose
Wire pulling forceps

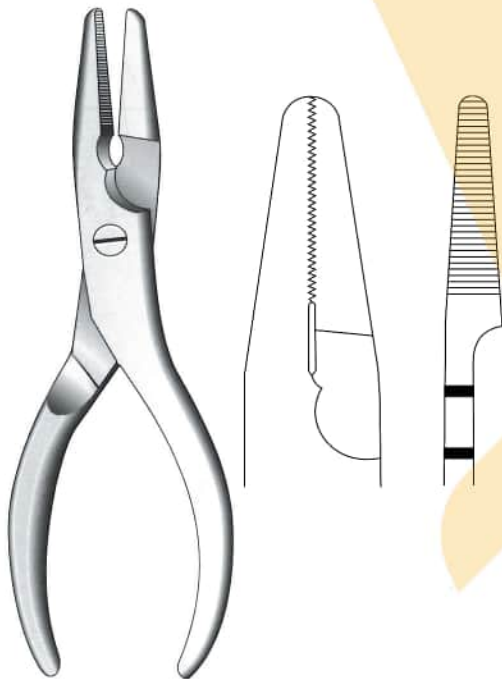

MO-13-994
16.5 cm / 6 1/2"
3 mm tip
Flat nose plier

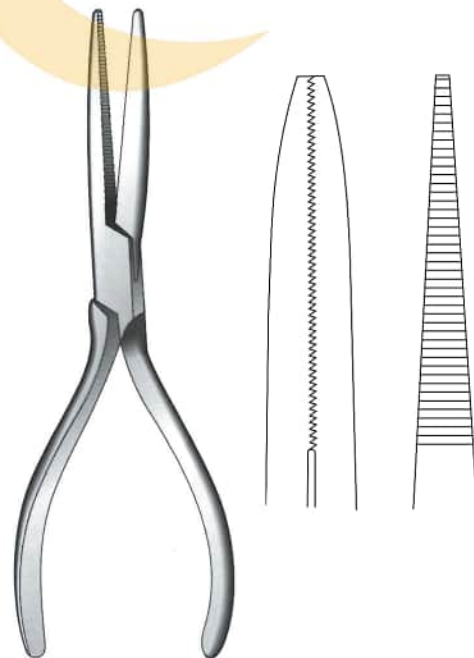

MO-13-995
18 cm / 7"
Jaw length: 2 1/2" 2
mm tip
Parallel grooved jaws
Long jaw needle nose plier

Orthopedic

Wire Tighteners, Drill Chucks and Wire Twisters

Draht Spann, spannfutter und Drahtzwirbel

Tensores cirra-hilo, mandril de sujecion y Torcer de alambre



Jacobs

MO-13-3200 Small
MO-13-3205 Large
Stainless steel

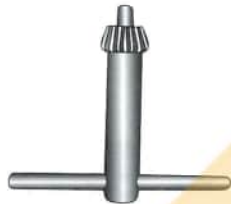

MO-13-3210
Key for Jacobs chuck
Stainless steel



MV-2603-00
Wire tightener



MO-13-3215 Small
MO-13-3220 Large
Chrome plated
MO-13-3225 Small
MO-13-3230 Large
Stainless steel



MO-13-3235
Key for chuck



MO-13-1127
18 cm / 7"
Small cerclage
wire twister
anodized aluminum
handle



MO-13-1128
Large
anodized aluminum
handle



MO-13-1129



MO-13-1130
Wire twister small
Stainless steel



MO-13-1131
18 cm / 7"
Large cerclage
wire twister
anodized aluminum
handle
Stainless
steel tip



MO-13-996
20 cm / 8"
Slip joint
plier 10
mm tip
Maximum open-
ing 2"



MV-2608A	2.0 mm
MV-2608B	2.7 mm
MV-2608C	3.5 mm
MV-2608D	4.5 mm

MV-2608-00
Drill guide



MO-13-2930 13 cm / 5¼"
MO-13-2935 17 cm / 6½"



MO-13-2940 17 cm / 6½"
MO-13-2945 12.5 cm / 5"
With side cutter



MO-13-1001
18 cm / 7"

Orthopedic

Trephine & Depth Gauge

Trephine

Trepano



Hudson
10 cm / 4"
Trephine

	Hole size
M-13-051	12.7 mm / 1/2"
M-13-052	19 mm / 3/4"
M-13-053	25.4 mm / 1"
M-13-054	31.75 mm / 1 1/4"
M-13-055	38.1 mm / 1 1/2"



Michele
Trephine

		Inside Ø	Outside Ø
MO-13-997	Small	3 mm	5 mm
MO-13-998	Medium	4 mm	6 mm
MO-13-999	Large	6 mm	8 mm

Facilitates removal of wire and broken bone screws.



MO-13-1475 100 mm
MO-13-1476 50 mm
Aluminum type



MO-13-1480
40 mm



MO-13-1481
60 mm



MO-13-1482
80 mm



MO-13-1483
110 mm

Heavy Duty Locking Pliers & Needle Nose Locking Pliers
with a new reinforced, more durable jaw.

- Heavy duty jaws lock securely onto pins.
- Reinforced jaw hinge and housing are more rigid to
- Help prevent side to side shifting.
- Made from 300 and 400 series Surgical grade
- Stainless steel.
- Will not chip or contaminate other instrumentation
- Adjustment screw for easy control of jaw opening
- One handed, quick release self-locking lever.
- Available in three sizes.



MO-13-1002
17.5 cm / 6 7/8"
Tip width 7 mm
Maximum opening
1" Small



MO-13-1003
20 cm / 8"
Tip width 9 mm
Maximum opening
1" Medium



MO-13-1004
25.5 cm / 10"
Tip width 13 mm
Maximum opening
1" Large



MO-13-1005
24 cm / 9 1/2"
Length of jaw 2 1/2"
Tip width 5 mm
Jaws are parallel at 3 mm

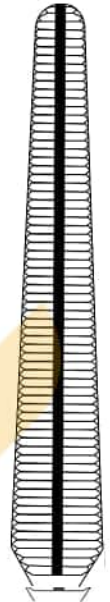

MO-13-1006
30 cm / 12"
Length of jaw 3"
Tip width 7 mm
Jaws are parallel at 5 mm
Large



Locking plier



Needle nose locking plier



Surgicon "Diamant"
MO-13-1007
16 cm / 6 1/4"



MO-13-1008
16 cm / 6 1/4"
for soft wires up to 2.5 mm \varnothing
for hard wires up to 2.0 mm \varnothing



MO-13-2950
16 cm / 6 1/4"
for soft wires up to 2.4 mm \varnothing
for hard wires up to 1.8 mm \varnothing



Instruments with Tungsten Carbide inserts
TC GOLD

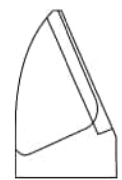

- | TC Gold | |
|-------------------|----------------|
| MT-13-1080 | 16 cm / 6 1/4" |
| MT-13-1081 | 18 cm / 7" |
| MT-13-1082 | 20 cm / 8" |



For up to
1.6 mm

- | TC Gold | |
|-------------------|----------------|
| MT-13-1050 | 14 cm / 5 1/2" |
| MT-13-1051 | 16 cm / 6 1/4" |
| MT-13-1052 | 18 cm / 7" |



- | TC Gold | |
|-------------------|----------------|
| MT-13-1010 | 22 cm / 8 3/4" |
- For soft wires up to 2.6 mm \varnothing
For hard wires up to 2.2 mm \varnothing

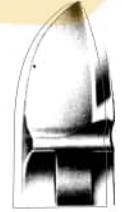
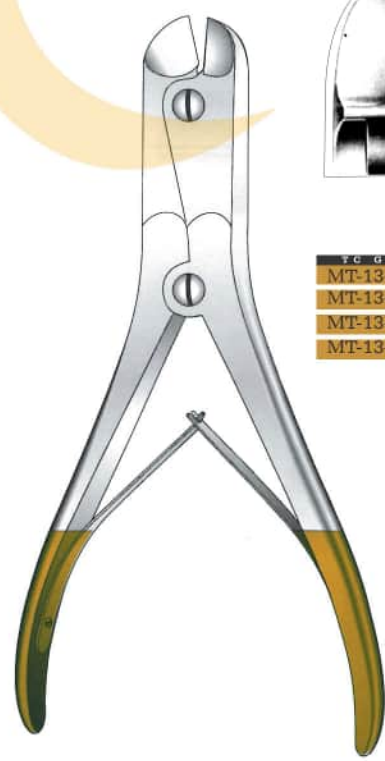

- | TC Gold | |
|-------------------|----------------|
| MT-13-1060 | 14 cm / 5 1/2" |
| MT-13-1061 | 16 cm / 6 1/2" |
| MT-13-1062 | 18 cm / 7" |
| MT-13-1063 | 22 cm / 8 3/4" |
- For soft wires up to 3 mm \varnothing
For hard wires up to 2.2 mm \varnothing

Instruments with Tungsten Carbide inserts

TC GOLD



MO-13-1012
15 cm / 6"
For soft wires up to 2.0 mm \emptyset
For hard wires up to 1.2 mm \emptyset



MO-13-1013
24 cm / 9 1/2"

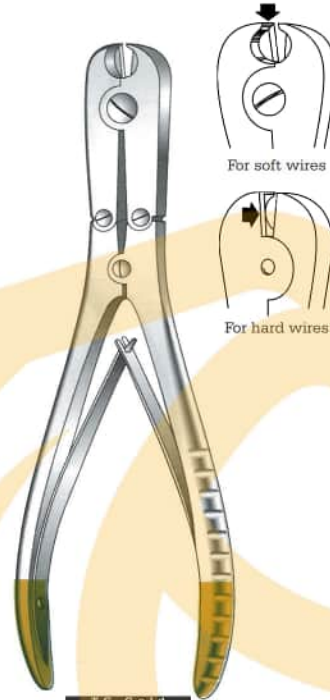

TC Gold
MT-13-1014
18 cm / 7"
For soft wires up to 2 mm \emptyset
For hard wires up to 1.5 mm \emptyset



TC Gold
MT-13-1015
17 cm / 6 3/4"
Angled slender pattern for wire removal (for soft wire up to diameter 0.9 mm) after sternum suture



TC Gold
MT-13-1016
22 cm / 8 3/4"
For soft wire up to 3.5 mm \emptyset
For hard wire up to 2.5 mm \emptyset



MO-13-2955 32 cm / 12 3/4"
For soft wire up to 3.0 mm \emptyset
For hard wire up to 3.0 mm \emptyset

Cutter for cutting off kirschner wires
tibia head screws, bolts & pins
up to 3 mm \emptyset



MO-13-2960 32 cm / 12 3/4"
Cut three wires at once
For soft wire up to 4.0 mm \emptyset
For hard wire up to 3.0 mm \emptyset



Instruments with Tungsten Carbide Inserts
TC GOLD



MO-13-3090
25 cm / 10"
For wires up to 3.0 mm
Head cutter

MO-13-3091 38 cm
/ 15"
For wires up to 4.0 mm
Head cutter

TC Gold		For wire
MT-13-1100	38.5 cm / 15"	5 mm
MT-13-1101	45 cm / 17 3/4"	6 mm
MT-13-1102	56 cm / 22"	7.5 mm

TC wire cutter



MO-13-3080 30 cm /
12"

MO-13-1013 47 cm /
18.5"

Cutter for cutting off
kirschner wires, tibia
head screws
bolts, pins up to 6
mm

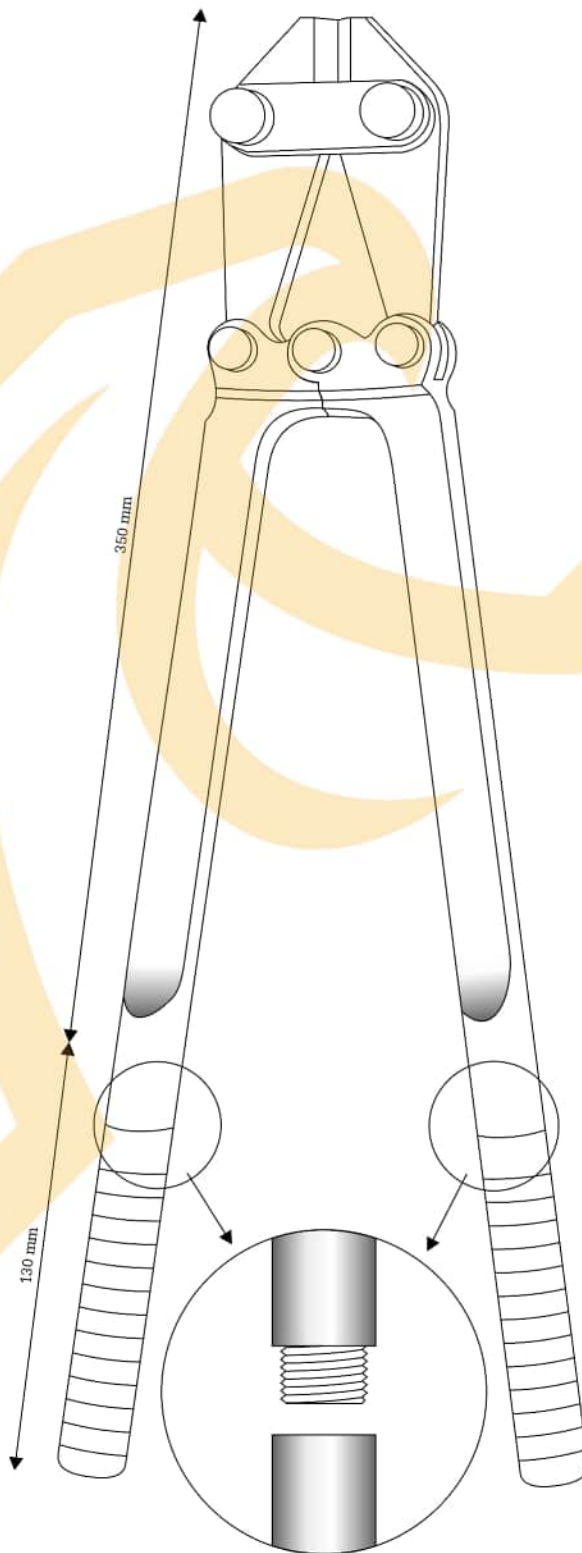

MO-13-1790
48 cm / 19"

Cutter for cutting off wires,
head screws
and pins up to 6 mm

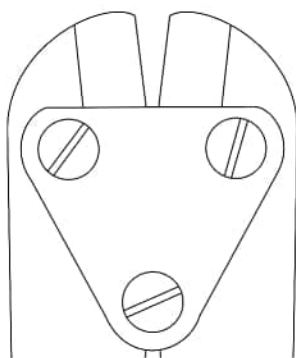

MO-13-1019
24 cm / 9½"

Plate cutting forceps
For cutting stainless steel
mini plates up to 1 mm



JO-21-1020
38 cm / 15"

Surgeon double action pin cutter
Heavy duty with Carb-N-Sert cutting blades
cut upto 3/16" Ø
Stainless steel

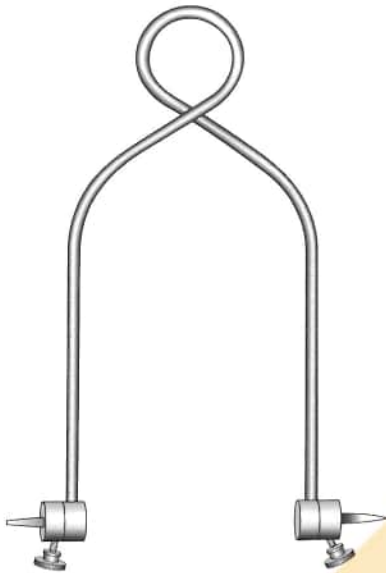

- | | | |
|----|--------------------|------------------------|
| | MO-13-2980 | 16 x 9 cm, 6¼" x 3½" |
| | For arm | |
| | MO-13-2982 | 21 x 11 cm, 8¼" x 4½" |
| | For thigh and knee | |
| | MO-13-2984 | 21 x 15 cm, 8" x 6" |
| | For femur and knee | |
| 10 | MO-13-2986 | 8.5 x 12 cm, 3¼" x 4¾" |
| 10 | MO-13-2988 | 11 x 17 cm, 4¼" x 6¾" |
| 10 | MO-13-2990 | 15 x 23 cm, 6" x 9" |

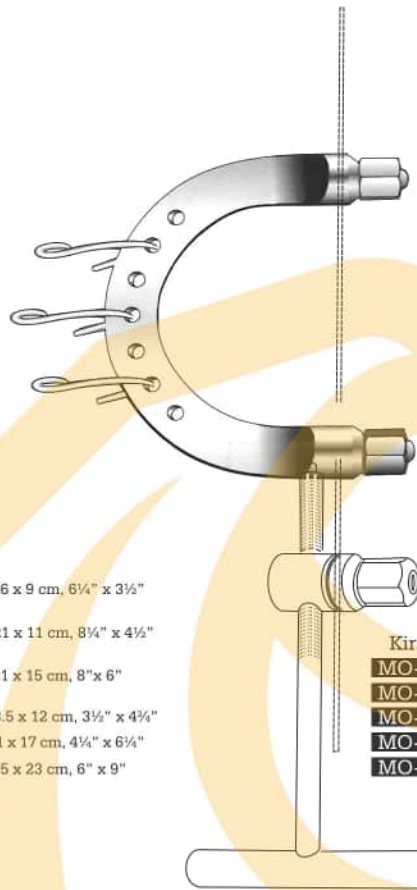

- | | | |
|--|-------------------|----------------|
| | Kirschner | H x B |
| | MO-13-3000 | 9.5 x 7.0 cm |
| | MO-13-3002 | 10.5 x 10.5 cm |
| | MO-13-3004 | 12.0 x 12.0 cm |
| | MO-13-3006 | 15.5 x 15.5 cm |
| | MO-13-3008 | 20.0 x 15.5 cm |



MO-13-3010



MO-13-3015

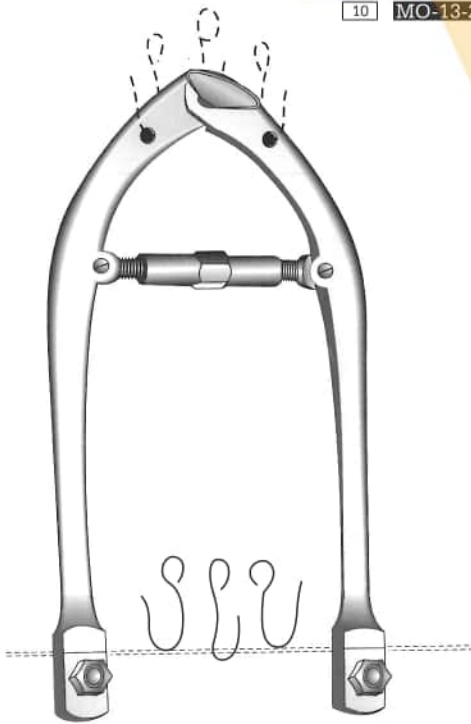

- | | |
|-------------------|------------|
| | h x b |
| MO-13-1027 | 18 x 10 cm |
| MO-13-1028 | 27 x 16 cm |

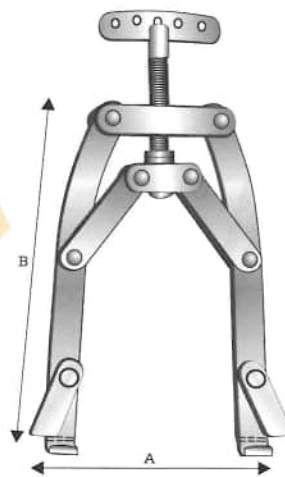

- | | | |
|--|-----------------------|-----------------------|
| | Kirschner U.S. | A x B |
| | MO-13-1031 | Small 100 13 x 20 cm |
| | MO-13-1032 | Medium 150 20 x 27 cm |
| | MO-13-1033 | Large |
| | MO-13-1034 | X-Large |



MO-13-1148
traction hooklet
for extension bows



MO-13-1149
traction hooklet
for extension bows

Orthopedic

Bone Wire Guides & Graft Passer

Drahtumföhrungsnadein

A ugujas Pass-hiles

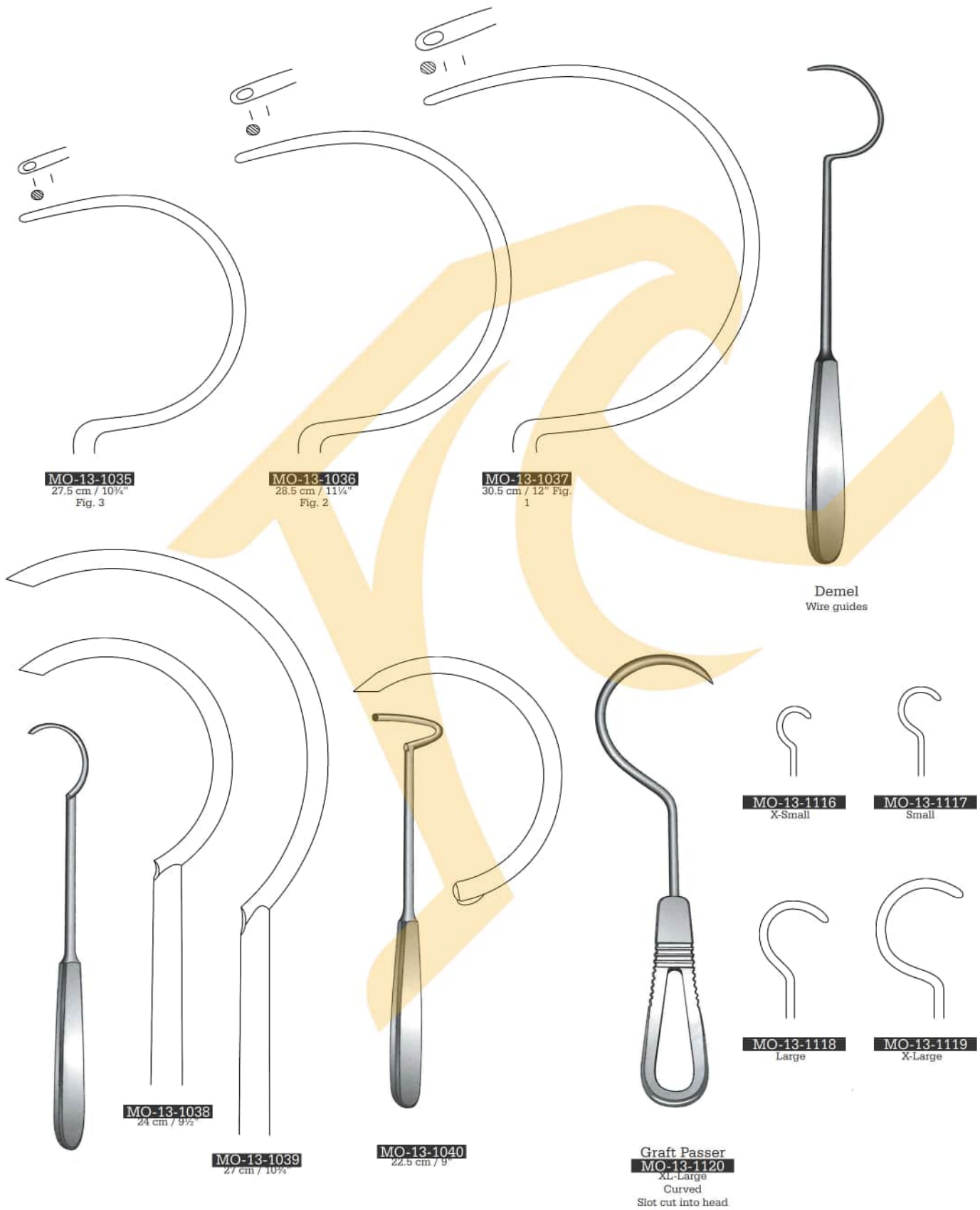

MO-13-1035
27.5 cm / 10 3/4"
Fig. 3

MO-13-1036
28.5 cm / 11 1/4"
Fig. 2

MO-13-1037
30.5 cm / 12"
1

Demel
Wire guides

MO-13-1038
24 cm / 9 1/2"

MO-13-1039
27 cm / 10 3/4"

MO-13-1040
22.5 cm / 9"

MO-13-1116
X-Small

MO-13-1117
Small

MO-13-1118
Large

MO-13-1119
X-Large

Graft Passer
MO-13-1120
XL-Large
Curved
Slot cut into head



Demel
MO-13-1041
 28 cm / 11"

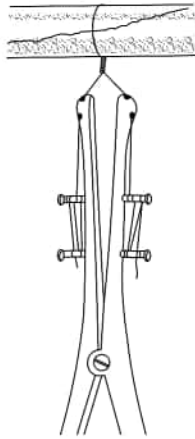

Loute
MO-13-1042
 21 cm / 8 3/4"



MO-13-1105
 Cerclage wire passer



MO-13-1795
 45 mm Ø



MO-13-1800
 70 mm Ø



Kuentscher
 26 cm / 10 3/4"
MO-13-1805 8 mm
MO-13-1806 10 mm
MO-13-1807 12.5 mm



Kuentscher
MO-13-1810
 35 cm / 14"



MO-13-1815
MO-13-1816



MO-13-1820 29 cm / 11 1/2"
MO-13-1821 37 cm / 14 3/4"
MO-13-1822 42 cm / 16 3/4"
MO-13-1823 49 cm / 19 1/2"



MO-13-1830 2.4 mm Ø
MO-13-1831 3.2 mm Ø
MO-13-1832 4.8 mm Ø
MO-13-1833 6.4 mm Ø

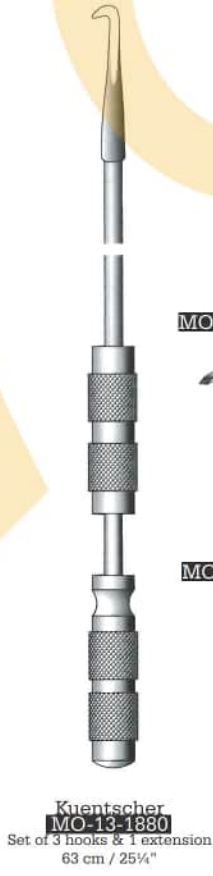



MO-13-1124 3.5 mm, 4.5 mm
MO-13-3030 4.5 mm, 3.5 mm
 20 cm / 8"
MO-13-3035 6 mm, 4 mm
 25 cm / 10"

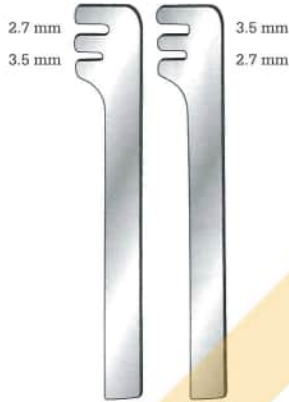

MO-13-1125
 14 cm / 5½"
 Plate benders
 Pair



MO-13-1126 1.5 mm
MO-13-3040 2 mm
 13 cm / 5¼"
MO-13-3045 1.8 mm
 12 cm / 4¾"



JO-21-1138
 Large bone plate press
JO-21-3050
 Small bone plate press



MO-13-3055
 22 cm / 8¾"



MO-13-3060 23 cm / 9"
MO-13-3065 18 cm / 7"
 Thickness 14 mm
 Wide 9 mm
 Bone plate bender



MO-13-1122
 Plate bending plier



MO-13-1123
 Plate bending plier

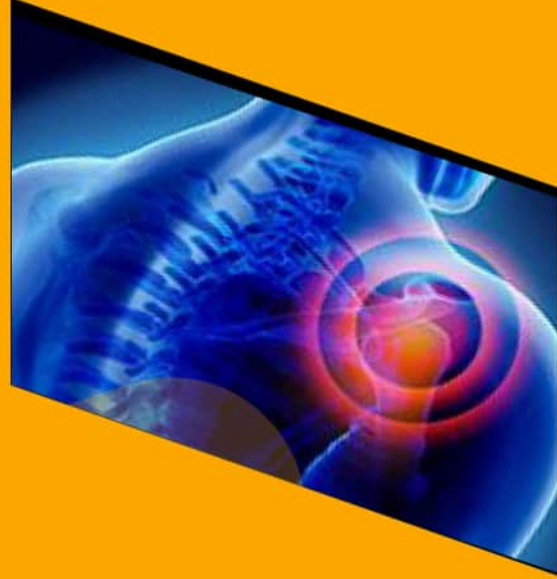
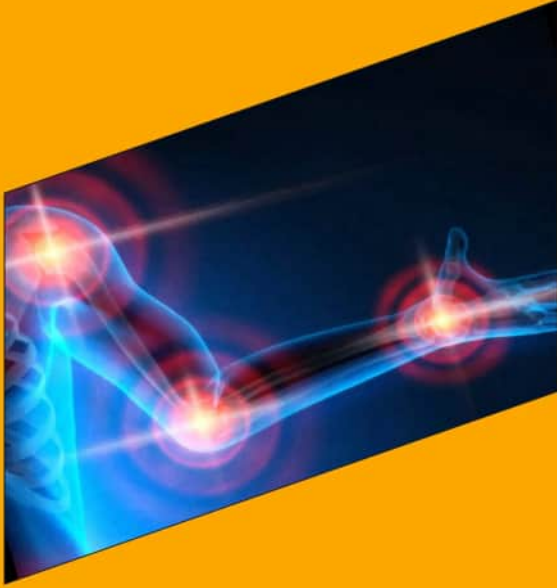

**MUKHTAR SURGICAL INSTRUMENTS (PVT) LTD.
RAI-PUR, UGOKI, WAZIRABAD ROAD
SIALKOT - 51310
PAKISTAN.**

PHONE: +92 305 8581687

MUKHTARSURGICAL.INS@GMAIL.COM

WWW.MUKHTARSURGICALINSTRUMENTS.COM